

Kinetic

Kinetic Plus E MVHR

Installation & Commissioning



Stock Ref. N°
449059 Kinetic Plus E

Vent-Axia®

PLEASE RETAIN THESE INSTRUCTIONS WITH THE PRODUCT.



IMPORTANT SAFETY INFORMATION



PLEASE READ THESE INSTRUCTIONS CAREFULLY BEFORE COMMENCING INSTALLATION.

1. Do not install this product in areas where the following may be present or occur:

- Excessive oil or a grease laden atmosphere.
- Corrosive or flammable gases, liquids or vapours.
- Subject to direct water spray from hoses.
- Ambient temperatures higher than 40°C and lower than -20°C.
- Possible obstructions that may hinder access to or removal of the unit.

2. All wiring must be in accordance with the current IEE wiring regulations BS7671, or appropriate standards of your country. Installation should be inspected and tested by a suitably qualified person after completion.

3. Ensure the mains supply (voltage, frequency and phase) complies with the rating label.

4. The unit should be provided with a local double pole fused spur fitted with a 3A fuse having a contact separation of at least 3mm.

5. These units must be earthed.

6. Precautions must be taken to avoid the back-flow of gases into the building from the open flue of gas or other fuel-burning appliances.

7. This appliance is not intended for use by persons (including children) with reduced physical, sensory or mental capabilities, or lack of experience and knowledge, unless they have been given supervision or instruction concerning use of the appliance by a person responsible for their safety.

8. Young children should be supervised to ensure that they do not play with the appliance.

INSTALLATION GUIDANCE

1. The installer is responsible for the installation and electrical connection of the sentinel system on site. It is the responsibility of the installer to ensure that the equipment is safely and securely installed and left only when mechanically and electrically safe.

2. All regulations and requirements must be strictly followed to prevent hazards to life and property, both during and after installation, and during any subsequent servicing and maintenance.

3. The unit's condensate drain must be connected to the building's wastewater drainage system.

4. Certain applications may require the installation of sound attenuation to achieve the sound levels required.

5. The unit must not be connected directly to a tumble drier.

6. The supply and exhaust valves must be fully opened prior to commissioning.

7. The supply air must be drawn from the exterior of the property.

8. The unit should be allowed to stabilise during commissioning for a minimum period of 5 minutes when changing between boost and normal speeds.

9. Ensure that the unit's external grilles are a minimum of 1500mm apart. The exhaust grille should be located at least 600mm away from any flue outlet. The inlet grille should be located 2000mm away from any flue outlet.

10. This product and associated duct installation should be carried out in accordance with the domestic ventilation compliance guide.

Disposal



This product should not be disposed of with household waste. Please recycle where facilities exist. Check with your local authority for recycling advice.

About this Document

Contents

Important Safety Information.....	2
Installation Guidance.....	2

Product Description

Kinetic Plus E.....	4
---------------------	---

Technical Data 5

KINETIC Plus E Performance graph.....	6
Installation.....	7
Overview.....	7
Before Installation of the Unit.....	7
Unit Installation.....	7
Electrical Installation.....	16
Powering Up the Unit.....	18

Commissioning

Overview.....	19
Commissioning Control.....	20

Maintenance

Filter Maintenance.....	22
12 Monthly Maintenance.....	22

Spares 23

Product Fiche 24

UK Building Regulations (Part F) Declaration of Conformance

Kinetic Plus E conform to the 2010 Building Regulations (Part F - Means of Ventilation) installed performance of a ducted mechanical extract fan when installed in accordance with the instructions in this document and the domestic ventilation compliance guide.

Note:

Read in conjunction with the User Instructions manual 445350.

Kinetic Plus E

The Vent-Axia **Kinetic Plus E Mechanical Ventilation/Heat Recovery (MVHR)** is heat recovery unit designed for the energy efficient ventilation of houses and similar dwellings, conforming to the latest requirements of the Building Regulations document F 2010.

The unit is designed for continuous 24 hour exhaust ventilation of stale moist air from bathrooms, toilets and kitchens. As the stale air is extracted, a heat exchanger within the unit transfers up to 94% of the heat and transfers it into the supply air entering the bedrooms and lounge.

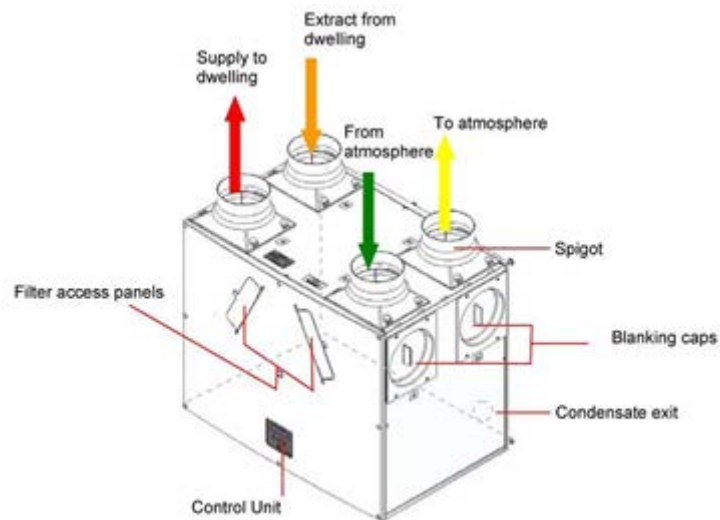

Figure 1: Kinetic Plus E (Front of Unit as supplied)

A wide range of sensors is available that can be used to switch Kinetic Plus E from normal to boost speed and they are:

- TimeSpan
- Air Quality Sensor
- Ambient Response Humidity
- Vent-Axia HumidiSwitch
- Vent-Axia ThermoSwitch
- Normal Boost Switch
- Vent Wise

Technical Data

Performance	Kinetic Plus E
Airflow	Maximum, FID, 500 m³/h Normal factory set at minimum Boost factory set at minimum (For commissioning graphs see page 6)
Sound levels (@ 3 m)	24 dB(A) (normal), 34 dB(A) (boost)
Power	
AC Voltage Input	220-240 V AC (single phase)
AC Frequency Input	50 Hz nominal
Rated Power	190 W (max.)
Physical	
Height (excluding spigots)	630 mm
Width (excluding spigots)	775 mm
Depth	524 including filter flap hinge protrusion
Weight	24 kg
Spigot diameter	150 mm
Condensate pipe diameter	22 mm
Environmental	
IP Rating	IP22
Operating Temperature	-10°C to +45°C
Air Intake Temperature	As above
Operating Humidity	0% to 95% RH
Storage Temperature	-10°C to +45°C
Storage Humidity	0% to 95% RH

For all other technical details, please see the Product Catalogue or our website at www.vent-axia.com

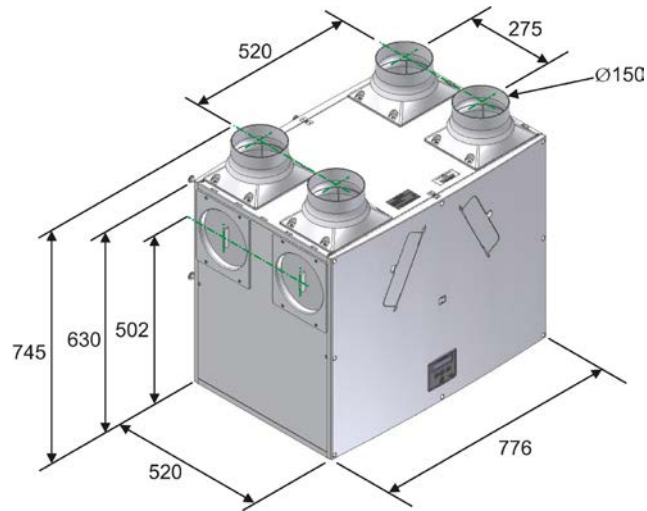
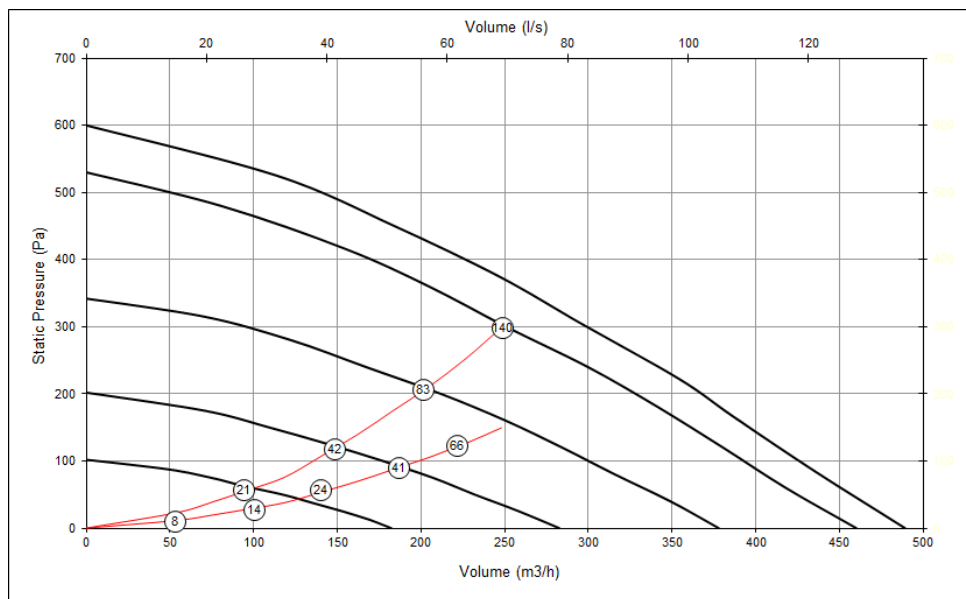

Figure 2: Kinetic Plus E Dimensions

KINETIC Plus E Performance graph for Vertical and Horizontal Discharge



Note: Graph show 2 typical system curves with total unit input power in Watts.

Overview

The following instructions are intended to help prevent potential hazards and installation should only be carried out by a qualified electrician and installer.

NOTE: we advise installers to fix all mains and sensor wiring prior to fixing the MVHR unit in position.

Before Installation of the Unit

Inspect the Unit

When taking delivery of the unit, check the items delivered against the enclosed delivery note. Inspect the unit for damage in transit. If in doubt, contact Customer Services. Each box contains a Kinetic Plus E MVHR unit and an accessory pack containing wall brackets, condensate drain link pipes, worm-drive clips, fixings and product documentation.

Lift and Move the Unit Safely

On page 5 check the weight of the unit that you are installing. Always use appropriate lifting techniques and appliances when moving heavy equipment.

Check Site Requirements and Safety Notices

Check that the physical and environmental conditions for the site meet, or exceed, the requirements detailed in the *Technical Specification* on page 5.

Read and observe the safety notices listed in *Warnings and Safety Information* on page 2.

Unit Installation

The Kinetic Plus E unit is typically installed on a wall in a utility room, storage cupboard, roof void, or similar.

The wall should have sufficient strength to support the unit.

Take into consideration the position of the electrical services and the condensate drain.

Ensure there is an adequate access for installation, operation and maintenance.

It is recommended that a local disconnection mains and sensor terminal box is installed within 1m of the unit to facilitate future maintenance.

The unit **MUST** always be mounted vertically with ducting exiting vertically or horizontally. Do not use this unit as a support for any other equipment.

Select Unit Orientation

The unit is supplied from the factory with the condensate exit (and the atmosphere spigots) to the right of the unit, when viewed from the front. Access is required to the Control Unit on the front of the unit in order to commission, operate and maintain the unit. If the unit is to be installed as supplied, skip the following section and go to Vertical Discharge Condensate Installation on page 10.

If the orientation of the condensate exit (and the atmosphere spigots) would be better suited on the left of the unit, the front Control Unit and the rear Cable Inlet Plate can be swapped over to allow the unit to be installed in the opposite orientation.

Installing the Unit in the Opposite Orientation (LH Condensate)

Installing the unit in the opposite orientation involves removing the front cover (and associated Control Unit Panel), and the rear cover (and associated Cable Inlet Plate), rotating the unit chassis and covers through 180 degrees and then re-attaching them.

This moves the condensate drain exit from the right (rear) corner of the unit to the left (front) corner of the unit, when viewed from the front (viewing the Control Unit).

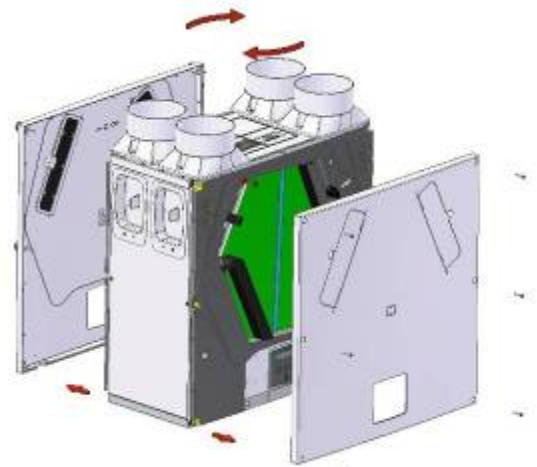

The arrow labels on the top edge of the Covers should be correctly matched to the arrow labels on the top of the Case.

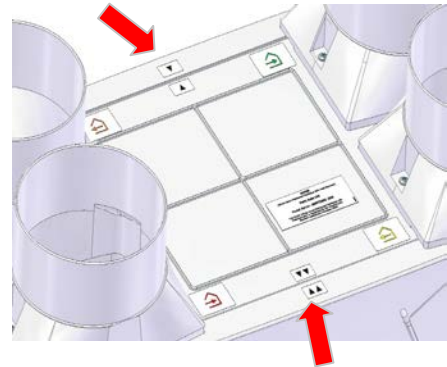

1. Remove the front and rear covers by unscrewing the) fixing screws on both covers.
2. Eight fixing screws on each cover.

3. Remove the 2 screws and detach the Electrical Cover from the front of the unit.

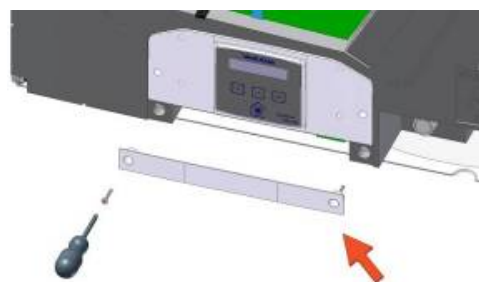

Installation

4. Remove the 2 screws and detach the Control Panel and disconnect the mains lead.



5. Disconnect the connection looms.

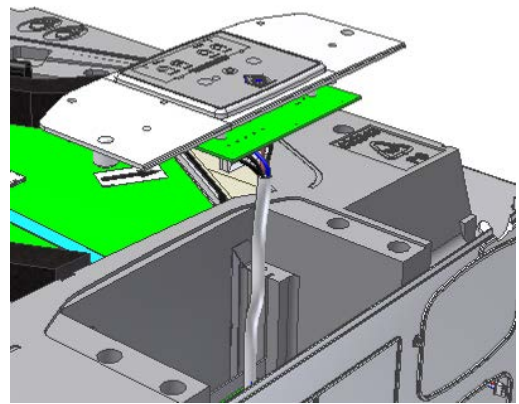

6. Disconnect all the wiring looms from control panel.

7. Remove the 2 screws and detach the rear Cable Inlet Plate.

Note that the grommets shown may be replaced by easy knock-out positions. If these are required, ensure that you use a grommet or gland to protect against potential water ingress.

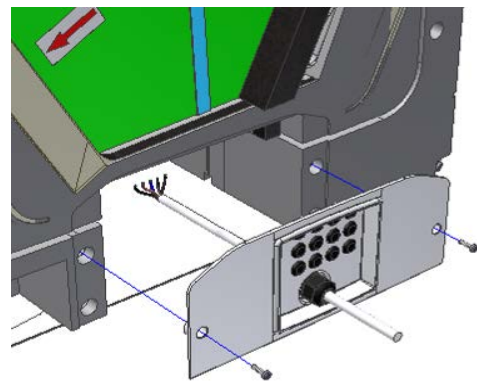

7. Re-attach the Cable Inlet Plate on the opposite side of the unit.
8. Fit the Control Panel on the opposite side of the unit. Taking care to reconnect the 2-way, 3-way and internal connectors to the control panel before securing the panel to the unit.
9. Re-connect the mains cable: L, N, E, LS1 and LS2.
11. Leave the front and rear covers off the unit.
12. For vertical discharge condensate connection continue on page 10, or for horizontal discharge condensate connection go to page 11.

Vertical Discharge Condensate Installation

Note

The 22 mm diameter condensate pipe is suitable for standard 22 mm plastic push-fit fittings and can be connected vertically underneath the unit or horizontally at the rear.

To install the vertical discharge condensate:

1. For vertical discharge, remove the rear cover and locate the condensate stub at the rear of the unit.



2. Remove the black Cap from the end of the condensate stub at the rear of the unit.



3. Fit the vertical condensate pipe and secure with worm drive clip

The condensate pipe can be attached with a worm drive clip to a 22 mm vertical pipe.

Fit a 'U' bend condensate drain having a minimum of a 60mm water seal or a HepvO valve to the building's foul water drainage system and ensure there is a minimum 3 degree fall to allow condensate drainage.

Both left hand and right hand condensate drain pipes are supplied for use as appropriate depending on the orientation of the unit.

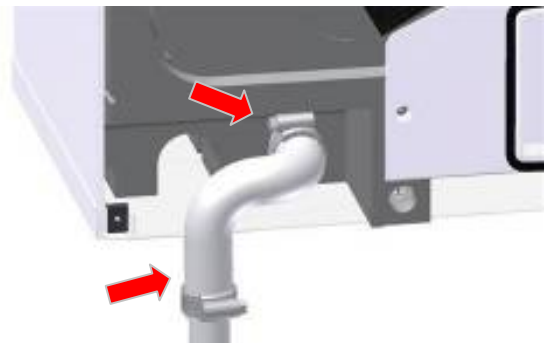

4. Go to Spigot Installation on page 13.

Horizontal Discharge Condensate Installation

To install the condensate horizontal discharge:

1. For horizontal discharge, remove the front cover and locate the condensate stub at the front of the unit.

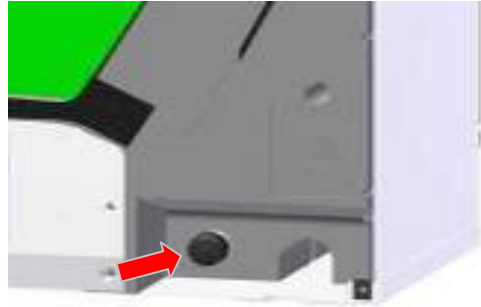

2. Remove the Black Cap from end of condensate stub at the front of the unit.



3. On the Kinetic Plus E drill a diameter 32mm hole using the indent provided in the moulding as a guide.

The hole is a clearance hole for a diameter 22 mm pipe and so may vary a little from this guidance.

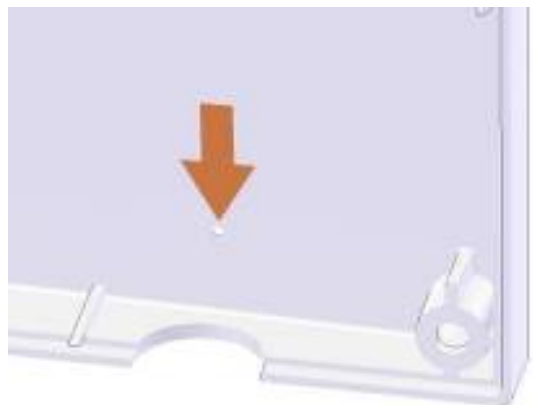

- 4. N.B. SEE “WALL MOUNTING” on pages 14 to 16 for information on marking out the wall for the position of the condensate drain and wall mounting brackets.**

Fit Vertical discharge 32mm waste pipe (fitted with 22 / 32mm reducer).

Fit a 'U' bend condensate drain having a minimum of a 60mm water seal or a HepvO valve to the building's foul water drainage system and ensure there is a minimum 3 degree fall to allow condensate drainage.



- 5. Fit the 180 degree bend supplied to a 22mm diameter x 280mm long condensate pipe with worm drive clip.**



- 6. Fit pipe assembly into waste pipe and secure 90 deg elbow to condensate spigot with worm drive clip.**



Spigot Installation

Air entry/exit spigots may be fitted on either the top or the side of the unit for vertical or horizontal entry or exit. Attach the spigots, depending on the space available for the ducting and orientation of the unit. Always fit the blanking caps to the entry or exit hole not in use to ensure the correct airflow into and out of the unit.

Note: Kinetic Plus E units have spigots suitable for either diameter 150 mm ducting (UK model) or for diameter 180 mm ducting (rest of EU model). The diameter 180 mm spigots come complete with self adhesive foam adaptors to enable it to be used with either diameter 180 mm ducting or diameter 200 mm ducting. These foam adaptors are to be fixed to the outside of the spigot for diameter 200 mm ducting.

To move the spigots:

1. Remove the spigot by unscrewing the screw(s) securing it to the chassis. Then pull the spigot firmly from the entry/exit hole.
2. Remove the blanking cap by unscrewing the screw(s) securing it to the chassis. Then pull the blanking cap firmly from the entry/exit hole.
3. Swap over the spigot with the removed blanking cap.
4. Insert the spigot into the entry/exit hole and secure with the retaining screw(s).
5. Insert the blanking cap into the entry/exit hole and secure with the retaining screw(s).



N.B. Before finally fixing the unit into position it may be more convenient to make the electrical connections; including the mains connections and any wiring for sensor(s) or switch(es).

Wall Mounting Kinetic Plus E

1. Refit the front and rear covers if they have been removed.
 2. Ensure five off wall bushes are fitted to the rear cover, three along the top row of screws and two along the middle row.
 3. Mark the condensate and wall bracket positions using the template below. A paper copy can be obtained from Vent-Axia Technical Support.
 4. Fit metal wall brackets (supplied) to the wall using appropriate fixings.
 5. Fit the stand-off feet in place, supplied in the accessory bag.
 6. Lift unit and locate the wall bushes onto the bracket.
- The unit should now be physically installed in its intended operating location.
7. Ensure that the condensate drain is connected as described on page 12.

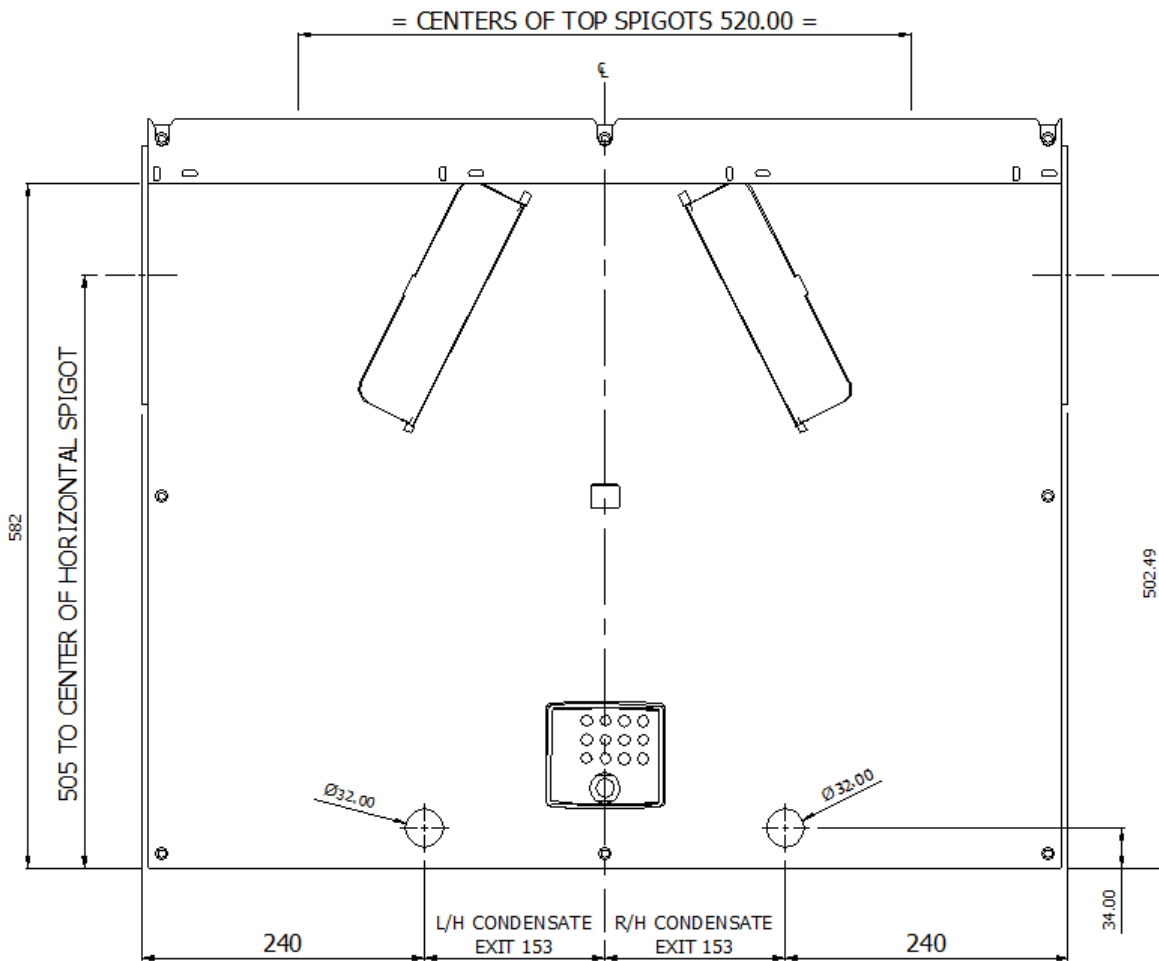

Kinetic Plus E Wall mounting dimensions

Attaching the ducting:

1. Always use a short piece of flexible duct 100-150 mm long, extended to its full length when connecting to ductwork.
2. Securely connect this ducting to the spigots using worm-drive clips or cable ties.
3. Insulate any ducting passing through an unheated space to prevent any heat losses and surface condensation.

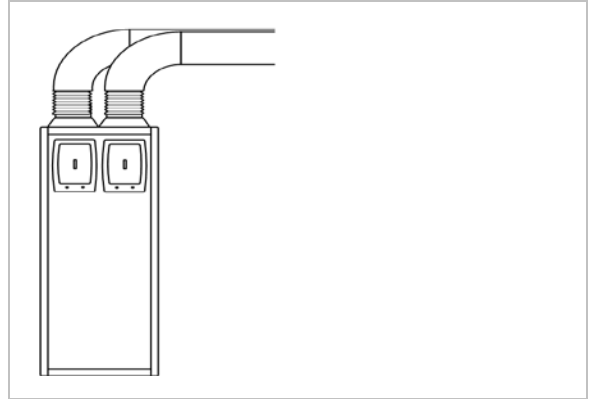

Electrical Installation

Connect Switches and Sensors

The unit can be switched to boost by applying 230 V to the LS1 or LS2 inputs. Alternatively, the boost button on the control unit may be used.

Table 1: Mains Cable Connections

Terminal No.	Name	Cable connection	Description
L	Mains Live	Brown	220-240 V AC, 50 Hz input
N	Mains Neutral	Blue	220-240 V AC, 50 Hz input
EARTH	Mains Earth	Yellow/Green	Earthing connector
LS1	Switched Live 1	Black	220-240 V AC, 50 Hz input
LS2	Switched Live 2	Grey	220-240 V AC, 50 Hz input

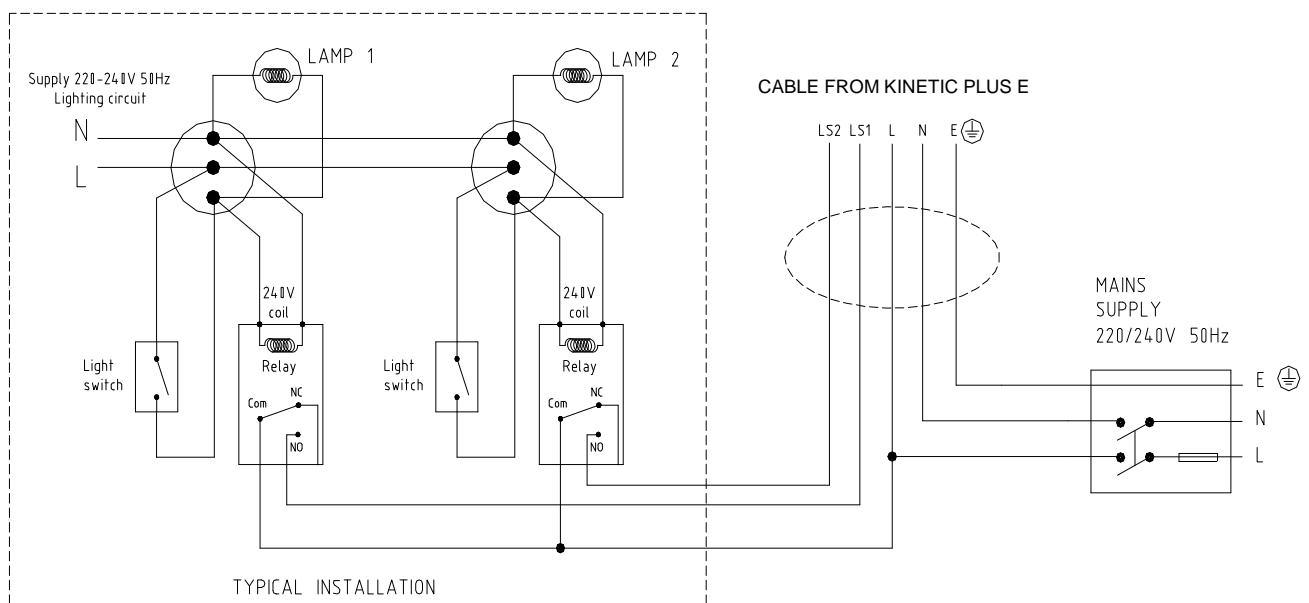

Connect the Power Supply



WARNINGS

1. MAINS SUPPLY VOLTAGES (220-240 V AC) ARE PRESENT IN THIS EQUIPMENT WHICH MAY CAUSE DEATH OR SERIOUS INJURY BY ELECTRIC SHOCK. ONLY A QUALIFIED ELECTRICIAN OR INSTALLER SHOULD CONNECT THE POWER SUPPLY TO THIS UNIT.
2. THIS UNIT MUST BE CORRECTLY EARTHED.

This unit is designed for operation from a single-phase alternating current source (220-240 V AC). A 1.5 m cable is connected internally to the unit for connection to a switched fused spur.

To connect the power supply:

1. Ensure the local AC power supply is switched off.
2. One end of the power cable supplied is already connected to the unit and routed through the Cable Inlet Plate via a suitable gland to ensure the IP rating of the unit is not affected.
3. Connect the other end of the cable to the switched fused spur.
4. Use cable clamps and clips to secure the cable, as appropriate.

Connecting a Boost (Light) Switch

A Switched Live (LS1 or LS2) may be used to boost the airflow when a light is turned on, for instance in a bathroom or kitchen. Note that the LS2 connection has a boost start time delay of 5 minutes.

In the event that the unit is inadvertently left running on boost, it will revert to normal speed after 2 hours.

Power supplied to the unit via the LS1 or LS2 connections must be supplied via the same circuit as the incoming L mains as indicated on page 16.

Powering Up the Unit

Switching On

Switch on the power at the mains supply isolator feeding the unit and the fan motors will start.

Switching Off

Turn the power off at the mains supply isolator switch.

Overview

The instructions in this section are intended to provide configuration and operation information for setting up the equipment.

Follow good practice when commissioning the unit. Ensure that the system is installed according to the system designers intent incorporating any acoustic ducting, that all joints are air tight, ducting is well supported, bends are avoided close to vents, and that the vent valves are fully open at the start of the commissioning process.

The following is attached to the unit and should be used as a check list prior to setting the air flows.











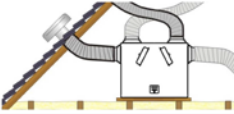

Vent-Axia

MVHR Installation Checklist

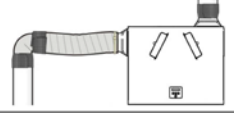
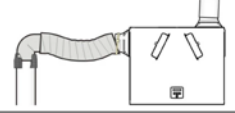
REQUIRED TO BE COMPLETE TO COMPLY WITH CONDITIONS OF WARRANTY,
but does not affect statutory rights.

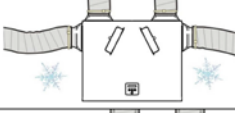
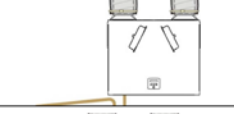
This is a short check list of good practice do's and don'ts that may affect the safety or functionality of the installation. It is not a complete list of what is required. They must be complied with in order to ensure that the installation performs as expected.

Unit Serial number: _____ Installer's name: _____

Check			Date and initials
1. Is the unit stable and horizontal with room around it to allow maintenance?			
2. Is any flexible ducting pulled taut to prevent moisture collection and avoids airflow issues?			
3. Are all joints in the ductwork sealed to prevent air leakage?			
4. Is the ducting insulated to prevent condensation and cooling or heating of the air?			
5. Does the condensate drain a) have the correct slope to ensure water runs away and b) is fitted with a trap to prevent smells			
6. If the condensate drain passes through a cold space is it insulated to prevent freezing?			

See the Installation Guide and Checklist at: http://www.vent-axia.com/files/domestic_ventilation_compliance_guide_2010.pdf

444012C

0216

Commissioning Control

The commissioning control enables you to adjust the fan flow rates. These are factory set to minimum and can be adjusted by using a small flat screwdriver through the four holes as shown below.

Estimate the setting from the performance graph on page 6, measure the flow from the extract and supply grilles in the usual way. Adjust the potentiometers to suit.

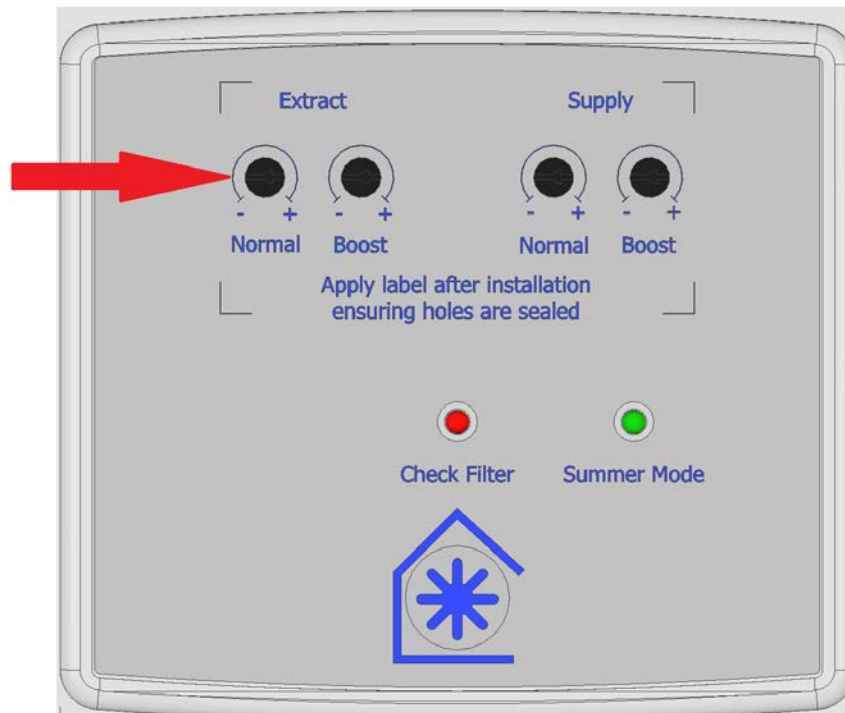





Figure 3: KINETIC PLUS E Controls

Summer Mode

The unit is equipped with a “Summer Mode” for use when the indoor temperature is higher than desired and the outdoor temperature is lower than the indoor temperature. This prevents the recovery of heat from the extracted air stream by stopping the supply fan, thereby allowing the cooler outdoor air to enter the property via for example open windows or doors.

Apply the label supplied in the accessory pack after the flow rates have been set to ensure that the holes are sealed. The label is applied to the area indicated by the printed corners.

Button Operation

Button	Function
	Press once to activate Boost mode. Press once again to exit Boost mode.
	To activate Summer Mode press 3 times in less than three seconds, after a short pause the green LED will illuminate and the supply fan will stop. To exit Summer Mode press 3 times in less than three seconds, after a short pause the green LED will turn off and the supply fan will restart.
	Press and hold for more than 10 seconds to reset after cleaning or replacing filter to reset Check Filter LED.

Notes:

The LED in the centre of the label lights after 6 months to indicate that the filters should be checked and cleaned / changed if necessary. See Maintenance section.

Maintenance

Heat recovery units require regular maintenance. The KINETIC PLUS E has been designed to facilitate access to enable maintenance to be carried out easily.



WARNING

THE FAN AND ANCILLARY CONTROL EQUIPMENT MUST BE ISOLATED FROM THE POWER SUPPLY DURING MAINTENANCE.

Filter Maintenance

Item	Action
Fan Filters	<p>When the red LED comes on, this is a reminder to check that the filters may be dirty and blocking the airflow. The rate at which the filters become dirty will vary hugely depending on the environment and the activity within the property.</p> <ol style="list-style-type: none"> 1. Open the filter flaps and remove the 2 filters. 2. Clean gently by tapping or carefully using a vacuum cleaner if necessary. 3. Replace the filters 4. Close the filter flaps. 5. To reset the timer for the LED, press and hold the  buttons for 10 seconds.

Periodic Maintenance

Item	Action
Fan Filters	<p>Change the Fan Filters.</p> <ol style="list-style-type: none"> 1. Open the filter flaps and remove the 2 filters. 2. Insert the replacement filters. 3. Close the filter flaps. 4. Reset the LED, press and hold the  buttons for 10 seconds.
Unit & Heat Exchanger Cell	<p>Inspect and clean the unit</p> <ol style="list-style-type: none"> 1. Isolate the mains power supply. 2. Open flaps and remove the 2 filters. 3. Remove front cover from the unit. 4. Slide out the heat exchanger. 5. Wash the outer cover and heat exchanger in warm water using a mild detergent (such as Milton Fluid) and dry thoroughly. <p>NOTE: Keep water away from all electrical components and wiring within the unit.</p>
Motors	<p>Inspect the motors for build-up of dust and dirt on the impeller blades, which could cause imbalance and increased noise levels. Vacuum or clean if necessary.</p>
Condensate Drain	<p>Check the condensate drain tube is secure and clear of debris. Clean if necessary.</p>
Fastenings	<p>Check that all unit and wall-mount fastenings are sufficiently tight and have not become loose. Re-tighten if necessary.</p>

Spares

The following spares may be ordered from Vent-Axia:

Kinetic Plus E Spares	
Part No	Description
403732	Control Board
404943	T1 Temperature Sensor
403702	Filters, 2 per pack
403733	Heat Recovery Cell
443354	Extract Motor
443353	Supply Motor
444057	Spigot, one per pack

PRODUCT FICHE

For Residential Ventilation Units (Complying Commission Delegated Regulation (EU)

No 1254/2014)

Name:	Vent-Axia
Model ID (Stock Ref.) :	Kinetic Plus E - 449059
SEC Class	A+
SEC Value ('Average')	-43.44
SEC Value ('Warm')	-17.84
SEC Value ('Cold')	-88.91
Label Required? (Yes/No=Out of scope)	Yes
Declared as: RVU or NRVU/UVU or BVU	BVU
Speed Drive	Variable Speed
Type HRS (Recuperative, Regenerative, None)	Recuperative
Thermal Eff: [(%), NA(if none)]	93
Max. Flow Rate (m3/h)	417.6
Max. Power Input (W): (@Max.Flow Rate)	190
LWA: Sound Power Level (dB)	N/A - (Ducted)
Ref. Flow Rate (m3/s)	0.081
Ref. Pressure Diff. (Pa)	350
SPI [W/(m3/h)]	0.28
Control Factor & Control Typology: (CTRL/ Typology)	
Control Factor; CTRL	0.65
Control Typology	Local Demand Control
Declared: -Max Internal & External Leakage Rates(%) for BVUs or carry over (for regenerative heat exchangers only), -&Ext. Leakage Rates (%) for Ducted UVUs;	<5% Internal, <5% External
Mixing Rate of Non-Ducted BVUs not intended to be equipped with one duct connection on either supply or extract air side;	N/A
Filter Warning (RVU)	Yes
For UVUs (Instructions Install Regulated Supply/Extract Grilles Façade)	N/A
Internet Address (for Disassembly Instructions)	www.vent-axia.com
Sensitivity p. Variation@+20/-20 Pa: (for Non-Ducted VUs)	N./A
Air Tightness-ID/OD-(m3/h) (for Non-Ducted VUs)	N./A
Annual Electricity Consumption: AEC (kWh/a)	1.92
Annual Heating Saved: AHS (kWh/a)	
AHS: Average	47.56
AHS: Warm	21.50
AHS: Cold	93.03

The **Vent-Axia**® Guarantee

Applicable only to products installed and used in the United Kingdom. For details of guarantee outside the United Kingdom contact your local supplier.

Vent-Axia guarantees its products for two years from date of purchase against faulty material or workmanship. In the event of any part being found to be defective, the product will be repaired, or at the Company's option replaced, without charge, provided that the product:-

- Has been installed and used in accordance with the instructions given with each unit.
- Has not been connected to an unsuitable electricity supply. (The correct electricity supply voltage is shown on the product rating label attached to the unit).
- Has not been subjected to misuse, neglect or damage.
- Has not been modified or repaired by any person not authorised by the company.

IF CLAIMING UNDER TERMS OF GUARANTEE

Please return the complete product, carriage paid to your original supplier or nearest Vent-Axia Centre, by post or personal visit. Please ensure that it is adequately packed and accompanied by a letter clearly marked "Guarantee Claim" stating the nature of the fault and providing evidence of date and source of purchase.

The guarantee is offered to you as an extra benefit, and does not effect your legal rights

Vent-Axia®

Head Office: Fleming Way, Crawley, West Sussex, RH10 9YX.

UK NATIONAL CALL CENTRE, Newton Road, Crawley, West Sussex, RH10 9JA

SALES ENQUIRIES: Tel: 0344 8560590 Fax: 01293 565169

TECHNICAL SUPPORT: Tel: 0344 8560594 Fax: 01293 532814

For details of the warranty and returns procedure please refer to www.vent-axia.com or write to Vent-Axia Ltd, Fleming Way, Crawley, RH10 9YX