

# EuroSeries® (ESR)

- Cowl & base moulded from recyclable polymeric material
- All sizes resistant to UV light
- Sizes 250 to 1000 dia are protected to IP54
- Optional backdraught shutters and bird guard (250-630mm)
- All models speed controllable
- Motor Insulation Class F, -40°C to +70°C operating temperature
- Reversible for supply or extract units
- Thermal overload for motor protection
- Performance tested to BS848 part 1 1980
- Designed for Data Centre and Warehouse cooling



A range of extract axial blade industrial roof fans incorporating the EuroSeries® ESP axial plate fan, featuring a single shot die cast aluminium blade & external rotor motor design.

Cowl and roof mounting base are moulded from specially formulated recyclable polymeric materials, which are high impact resistant and provide a rigid profile against strong winds and resistance to UV light. Standard colour BS00A05

EuroSeries® ESR units are suitable for flat or inclined roofs (max. angle 30°) and are designed for either kerb or purlin box mounting.

The EuroSeries® ESR range is available in eleven sizes with the extract performances up to 10.88m<sup>3</sup>/s, with pressure characteristics of up to 300Pa. All units are designed for & fully speed controllable.

## Air Operated Shutters & Bird Guards

The shutters fits beneath the cowl using fitting provided. Shutters should not be used when the fan performance is below 30% of maximum and the hinge should point up the roof incline.

The standard shutters for sizes 800 & 1000mm must not be used with 4 & 6 pole unit. Please enquire for special metal shutters. Bird Guards are manufactured to fit neatly between the roof cowl and the base.

## Impellers

All sizes are supplied with cast aluminium impellers, ensuring performance when working against outdoor conditions and abrasive airflow. All fans are reversible for Intake (approx 30% reduction in performance). Backdraught shutters should not be used when operated as an intake fan.

## Motors

External rotor motors are specially designed and styled for this range of fan. Ball bearings are greased for life. Rotors are dynamically balanced to ISO 1940. Sizes 250-1000mm, motors are protected to IP54, against

dust and moisture complying with BS EN 60529:1992. They are ribbed aluminium body castings for efficient cooling. Motor insulation is Class 'F' (from -40°C to +70°C).

## Electrical

Single phase 220-240V 50Hz. Capacitor start and run. Three phase 380-415V 50Hz. An IP54 terminal box is supplied with most models with 20mm and PGII entry. All motors are fitted with thermal overload protection which should be wired into all controller circuits and into starter contactors. Models are available with either 2, 4, 6 & 8 pole motors.

## Terminal Box

Are to IP54, as standard, protected against dust and water from any angle allowing outside applications.

## Performance

The fan performance is in accordance with tests to BS848 Part 1 1980.

## Sound Levels

Fan sound levels, measured in a reverberant chamber in accordance with BS848 Part 2 1985. Published dB(A) figures are free field sound pressure levels at 3m with spherical propagation at a reference level of  $2 \times 10^{-5}$  Pa (20 micro-Pascal). The sound power level spectra figures are dB with reference level of  $10^{-12}$  Watts (1 pico-watt). To ensure minimum noise levels during speed control, an auto transformer speed control is recommended.

### Fan Dimensions (mm)

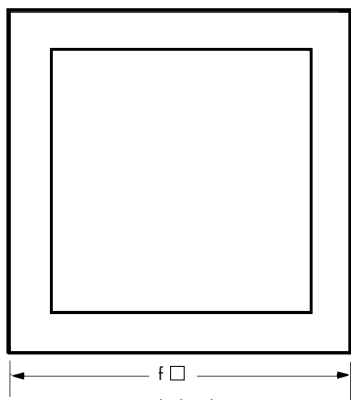
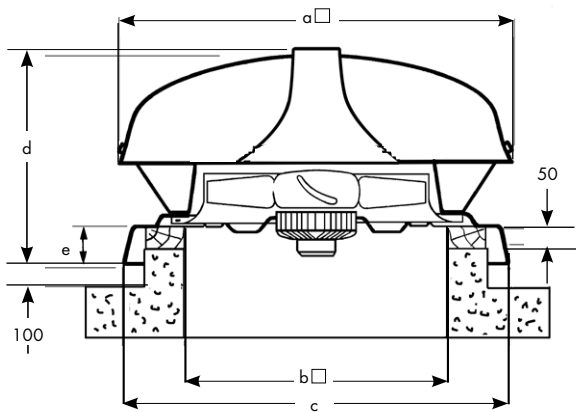

Kerb detail

Size	a	b	c	d	e	f	kg Max
250	700	475	737	411	97	675	13.25
315	700	475	737	411	97	675	16.3
355	700	475	737	411	97	675	16.3
400	800	575	830	466	97	775	18.4
450	800	575	830	466	97	775	20.3
500	950	715	1000	579	100	915	35.5
560	950	715	1000	579	100	915	35.5
630	1230	840	1100	731	105	1040	62
710	1230	840	1100	731	105	1040	62
800	1420	870	1190	731	105	1070	78
1000	1680	1070	1455	795	131	1270	134

### Purlin Box (mm)

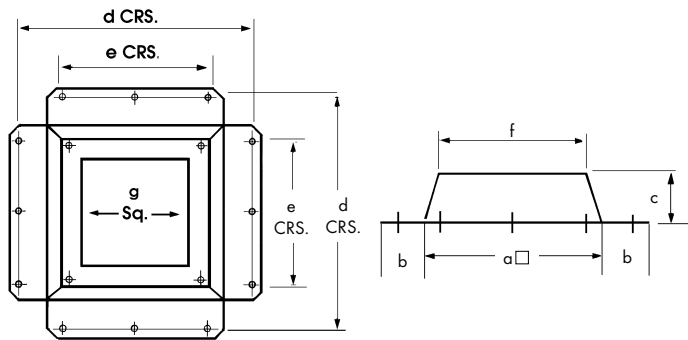

Size	a	b	c	d	e	f □	g □
250	625	90	240	765	400	590	460
315	625	90	240	765	400	590	460
355	625	90	240	765	400	590	460
400	725	90	240	865	500	705	565
450	725	90	240	865	500	705	565
500	890	70	250	990	650	850	640
560	890	70	250	990	650	870	700
630	1030	75	250	1140	760	985	775
710	1030	75	250	1140	760	985	840
800	980	37	267	1016	406	980	880
1000	1180	76	279	1294	508	1180	1080

# Performance Guide

250 to 450 dia. - 1 Phase - 2 & 4 Pole

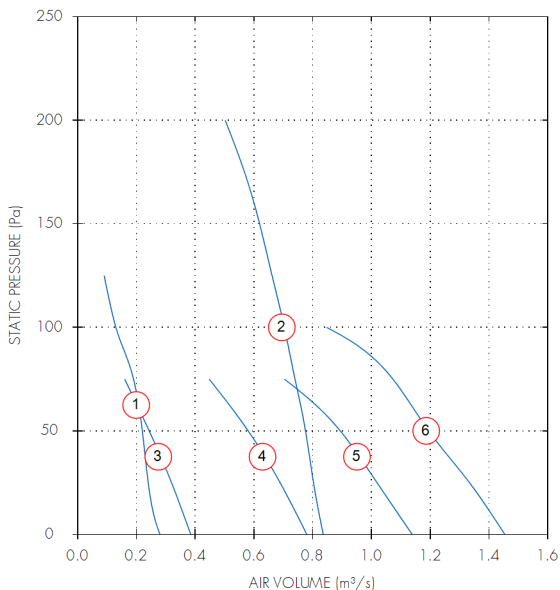

500 to 630 dia. - 1 Phase - 4 Pole

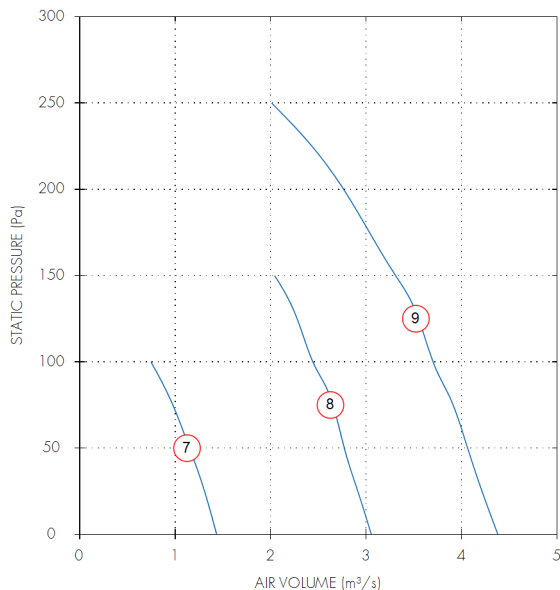

Dia.	Motor Phase	Stock Ref	Poles	r.p.m	IP Rating	Curve Ref.	m³/s @ Pa					Motor kW	S.C. Amps	F.L.C Amps	dB(A) @ 3m
							0	50	100	150	200				
250	1	ESR25012	2	2440	IP44	1	0.28	0.22	0.13			0.12	1.15	0.54	59
315	1	ESR31512	2	2690	IP54	2	0.84	0.78	0.7	0.62	0.5	0.56	7.2	2.4	64
315	1	ESR31514	4	1300	IP54	3	0.38	0.24				0.15	1.38	0.7	50
355	1	ESR35514	4	1330	IP54	4	0.78	0.58				0.19	1.45	0.84	53
400	1	ESR40014	4	1350	IP54	5	1.14	0.89				0.29	2.4	1.45	56
450	1	ESR45014	4	1370	IP54	6	1.45	1.19	0.85			0.36	3.6	1.6	61
500	1	ESR50014	4	1290	IP54	7	1.43	1.15	0.75			0.51	4.3	2.3	55
560	1	ESR56014	4	1320	IP54	8	3.05	2.77	2.44	2.04		1.35	21	6	63
630	1	ESR63014	4	1320	IP54	9	4.38	4.06	3.7	3.31	2.76	2.2	28	9.9	70

ESR25012, ESR31512 & ESR25014 not suitable for reverse airflow.

## Sound Power Level Spectra dB (ref 10<sup>-12</sup> Watts)

Dia.	Motor Phase	Stock Ref	Poles	Spectrum	63	125	250	500	1k	2k	4k	8k	dB(A) @ 3m
250	1	ESR25012	2	Inlet	69	70	76	76	70	70	67	59	57
250	1	ESR25012	2	Outlet	69	70	76	76	70	70	67	59	57
315	1	ESR31512	2	Inlet	69	73	79	74	74	76	73	66	61
315	1	ESR31512	2	Outlet	69	73	79	74	74	76	73	66	61
315	1	ESR31514	4	Inlet	70	68	66	61	60	62	58	51	47
315	1	ESR31514	4	Outlet	70	68	66	61	60	62	58	51	47
355	1	ESR35514	4	Inlet	65	70	67	65	64	64	62	55	50
355	1	ESR35514	4	Outlet	65	70	67	65	64	64	62	55	50
400	1	ESR40014	4	Inlet	70	72	67	66	65	65	64	56	51
400	1	ESR40014	4	Outlet	70	72	67	66	65	65	64	56	51
450	1	ESR45014	4	Inlet	69	76	73	72	70	71	70	62	57
450	1	ESR45014	4	Outlet	69	76	73	72	70	71	70	62	57
500	1	ESR50014	4	Inlet	65	75	69	70	70	71	69	62	56
500	1	ESR50014	4	Outlet	65	75	69	70	70	71	69	62	56
560	1	ESR56014	4	Inlet	100	90	89	84	82	79	75	68	67
560	1	ESR56014	4	Outlet	100	90	89	84	82	79	75	68	67
630	1	ESR63014	4	Inlet	82	86	79	79	80	78	75	70	64
630	1	ESR63014	4	Outlet	82	86	79	79	80	78	75	70	64

# Performance Guide

250 to 450 dia. - 3 Phase - 2 & 4 Pole

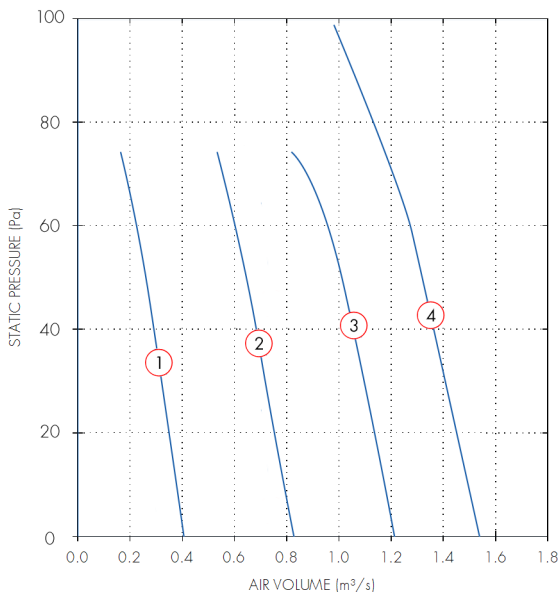

500 to 710 dia. - 3 Phase - 4 Pole

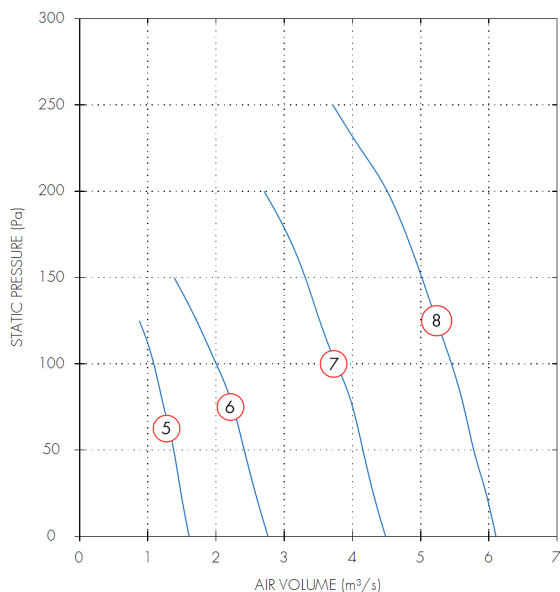

Dia.	Motor Phase	Stock Ref	Poles	r.p.m	IP Rating	Curve Ref.	m <sup>3</sup> /s @ Pa					Motor kW	S.C. Amps	F.L.C Amps	dB(A) @ 3m	
							0	50	100	150	200					250
315	3	ESR31534	4	1390	IP54	1	0.4	0.26				0.11	2.1	0.27	46	
355	3	ESR35534	4	1370	IP54	2	0.82	0.65				0.17	1.35	0.37	49	
400	3	ESR40034	4	1350	IP54	3	1.21	1.01				0.26	2.1	0.56	51	
450	3	ESR45034	4	1380	IP54	4	1.54	1.32	0.98			0.36	2.6	0.8	56	
500	3	ESR50034	4	1380	IP54	5	1.6	1.38	1.09			0.55	3.7	1.05	58	
560	3	ESR56034	4	1220	IP54	6	2.76	2.41	2	1.39		1.25	7.7	2.2	70	
630	3	ESR63034	4	1360	IP54	7	4.49	4.15	3.76	3.31	2.7	1.9	14	3.2	64	
710	3	ESR71034	4	1290	IP54	8	6.1	5.78	5.45	5.02	4.51	3.71	2.9	19	5.3	72

## Sound Power Level Spectra dB (ref 10<sup>-12</sup> Watts)

Dia.	Motor Phase	Stock Ref	Poles	Spectrum	dB(A) @ 3m								
					63	125	250	500	1k	2k	4k	8k	
315	3	ESR31534	4	Inlet	64	67	69	63	62	60	58	53	47
315	3	ESR31534	4	Outlet	64	67	69	63	62	60	58	53	47
355	3	ESR35534	4	Inlet	58	73	63	64	64	65	64	58	50
355	3	ESR35534	4	Outlet	58	73	63	64	64	65	64	58	50
400	3	ESR40034	4	Inlet	62	73	65	65	67	69	67	60	53
400	3	ESR40034	4	Outlet	62	73	65	65	67	69	67	60	53
450	3	ESR45034	4	Inlet	65	82	75	76	73	72	69	62	58
450	3	ESR45034	4	Outlet	65	82	75	76	73	72	69	62	58
500	3	ESR50034	4	Inlet	67	71	69	72	70	71	68	61	56
500	3	ESR50034	4	Outlet	67	71	69	72	70	71	68	61	56
560	3	ESR56034	4	Inlet	85	79	77	76	76	75	72	66	61
560	3	ESR56034	4	Outlet	85	79	77	76	76	75	72	66	61
630	3	ESR63034	4	Inlet	71	88	82	83	82	81	78	72	67
630	3	ESR63034	4	Outlet	71	88	82	83	82	81	78	72	67
710	3	ESR71034	4	Inlet	80	87	86	88	89	86	83	79	72
710	3	ESR71034	4	Outlet	80	87	86	88	89	86	83	79	72

# Performance Guide

315 to 710 dia. - 1 Phase - 6 Pole

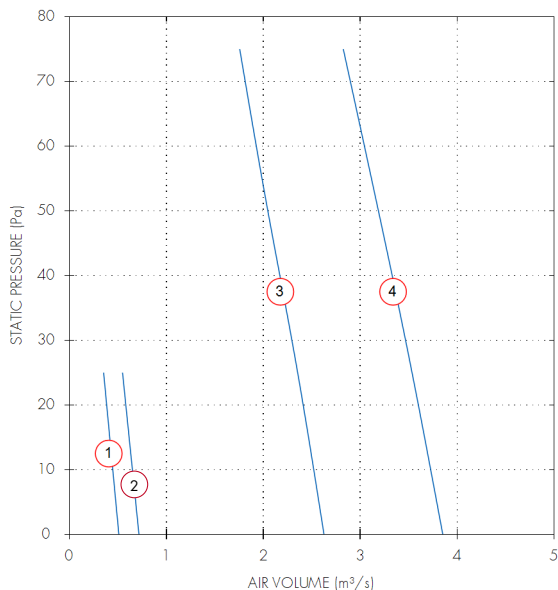

315 to 500 dia. - 3 Phase - 6 Pole

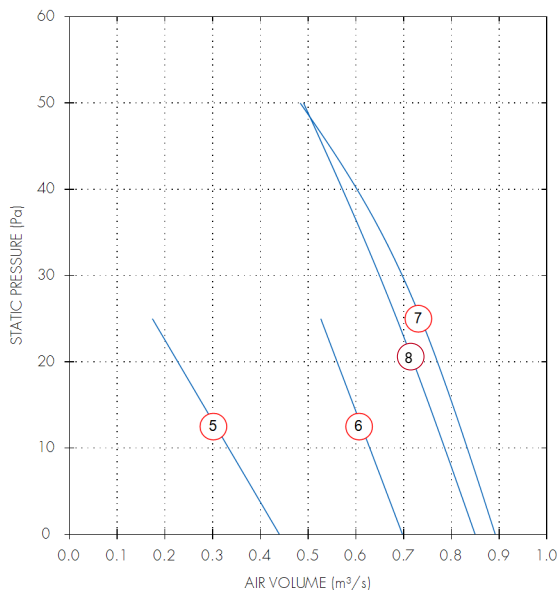

Dia.	Motor Phase	Stock Ref	Poles	r.p.m	IP Rating	Curve Ref.	m <sup>3</sup> /s @ Pa				Motor kW	S.C. Amps	F.L.C Amps	dB(A) @ 3m
							0	25	50	75				
355	1	ESR35516	6	950	IP54	1	0.51	0.35			0.09	1.2	0.46	44
400	1	ESR40016	6	940	IP54	2	0.72	0.55			0.13	1.4	0.6	45
630	1	ESR63016	6	880	IP54	3	2.63	2.35	2.05	1.76	0.6	5.3	2.7	57
710	1	ESR71016	6	850	IP54	4	3.85	3.53	3.19	2.82	0.89	8	4.1	60
355	3	ESR35536	6	910	IP54	5	0.44	0.17			0.09	0.5	0.25	45
400	3	ESR40036	6	920	IP54	6	0.7	0.53			0.11	0.9	0.28	50
450	3	ESR45036	6	890	IP54	7	0.89	0.74	0.48		0.12	1	0.28	51
500	3	ESR50036	6	900	IP54	8	0.85	0.69	0.49		0.23	1.5	0.56	56

## Sound Power Level Spectra dB (ref 10<sup>-12</sup> Watts)

Dia.	Motor Phase	Stock Ref	Poles	Spectrum	dB								dB(A) @ 3m
					63	125	250	500	1k	2k	4k	8k	
355	1	ESR35516	6	Inlet	59	59	60	57	56	57	55	46	42
355	1	ESR35516	6	Outlet	59	59	60	57	56	57	55	46	42
400	1	ESR40016	6	Inlet	76	74	70	65	63	58	52	44	48
400	1	ESR40016	6	Outlet	76	74	70	65	63	58	52	44	48
630	1	ESR63016	6	Inlet	88	85	81	77	76	70	64	58	60
630	1	ESR63016	6	Outlet	88	85	81	77	76	70	64	58	60
710	1	ESR71016	6	Inlet	83	83	84	80	78	74	70	72	63
710	1	ESR71016	6	Outlet	83	83	84	80	78	74	70	72	63
355	3	ESR35536	6	Inlet	60	61	60	56	56	56	54	46	42
355	3	ESR35536	6	Outlet	60	61	60	56	56	56	54	46	42
400	3	ESR40036	6	Inlet	60	60	62	59	60	60	58	50	45
400	3	ESR40036	6	Outlet	60	60	62	59	60	60	58	50	45
450	3	ESR45036	6	Inlet	63	72	66	63	63	62	59	48	48
450	3	ESR45036	6	Outlet	63	72	66	63	63	62	59	48	48
500	3	ESR50036	6	Inlet	78	73	68	67	68	66	59	51	52
500	3	ESR50036	6	Outlet	78	73	68	67	68	66	59	51	52

# Performance Guide

560 to 1000 dia. - 3 Phase - 6 Pole

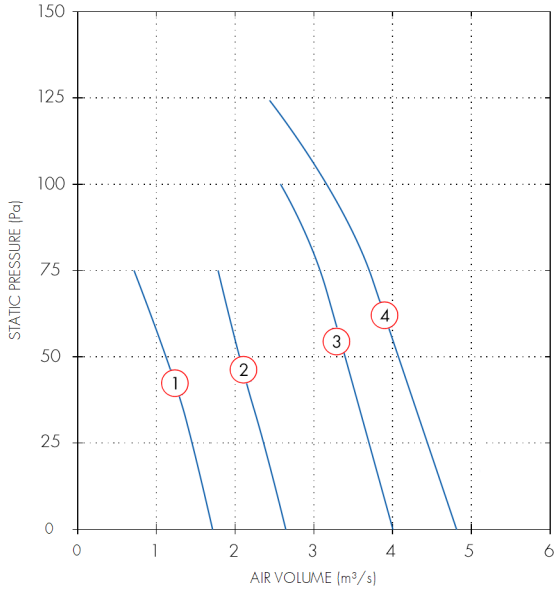

710 to 800 dia. - 3 Phase - 8 Pole

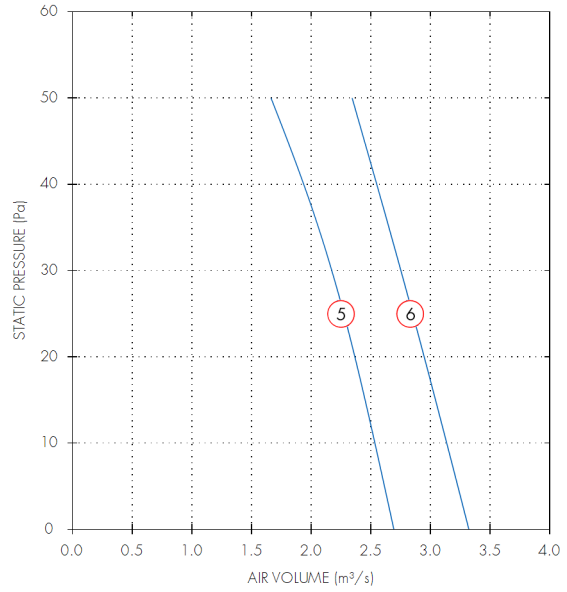

Dia.	Motor Phase	Stock Ref	Poles	r.p.m	IP Rating	Curve Ref.	m <sup>3</sup> /s @ Pa			Motor kW	S.C. Amps	F.L.C Amps	dB(A) @ 3m
							0	50	100				
560	3	ESR56036	6	860	IP54	1	1.72	1.16		0.36	1.75	0.74	56
630	3	ESR63036	6	890	IP54	2	2.66	2.07		0.59	3.6	1.3	59
710	3	ESR71036	6	860	IP54	3	4	3.4	2.58	1.1	7.7	2.2	62
800	3	ESR80036	6	900	IP54	4	4.81	4.08	3.18	1.4	7.7	2.2	64
710	3	ESR71038	8	630	IP54	5	2.69	1.66		0.43	3.3	1.1	55
800	3	ESR80038	8	670	IP54	6	3.32	2.34		0.69	5	1.75	58

## Sound Power Level Spectra dB (ref 10<sup>-12</sup> Watts)

Dia.	Motor Phase	Stock Ref	Poles	Spectrum	dB(A) @ 3m								
					63	125	250	500	1k	2k	4k	8k	
560	3	ESR56036	6	Inlet	67	72	72	68	68	68	65	57	53
560	3	ESR56036	6	Outlet	67	72	72	68	68	68	65	57	53
630	3	ESR63036	6	Inlet	67	78	76	74	73	72	77	59	60
630	3	ESR63036	6	Outlet	67	78	76	74	73	72	77	59	60
710	3	ESR71036	6	Inlet	80	77	78	75	76	75	70	64	60
710	3	ESR71036	6	Outlet	80	77	78	75	76	75	70	64	60
800	3	ESR80036	6	Inlet	73	83	79	75	75	77	74	64	62
800	3	ESR80036	6	Outlet	73	83	79	75	75	77	74	64	62
710	3	ESR71038	8	Inlet	75	75	73	71	72	70	64	57	56
710	3	ESR71038	8	Outlet	75	75	73	71	72	70	64	57	56
800	3	ESR80038	8	Inlet	75	75	73	71	72	70	64	57	56
800	3	ESR80038	8	Outlet	75	75	73	71	72	70	64	57	56

## Models & Accessories

Speed Controllers					
Fan Stock Ref	Electronic Stock Ref	Auto Transfor Stock Ref	Starter Stock Ref	Overload Stock Ref	Fan Stock Ref
1 Phase - 2 Pole					3 Phase - 4 Pole
ESR25012	SC5001	SPM5020	444744	444699	ESR31534
ESR31512	SC5030TK	SPM5035	444744	444701	ESR35534
1 Phase - 4 Pole					ESR40034
ESR25014	SC5001	SPM5020	444744	444696	ESR45034
ESR31514	SC5001	SPM5020	444744	444699	ESR50034
ESR35514	SC5030TK	SPM5020	444744	444699	ESR56034
ESR40014	SC5030TK	SPM5020	444744	444701	ESR63034
ESR45014	SC5030TK	SPM5020	444744	444701	ESR71034
ESR50014	SC5030TK	SPM5035	444744	444702	3 Phase - 6 Pole
ESR56014	SC5010TK	SPM5075	444744	444704	ESR35536
ESR63014	-	-	444744	444706	ESR40036
					ESR50036
1 Phase - 6 Pole					ESR56036
ESR35516	SC5030TK	SPM5020	444744	444698	ESR63036
ESR40016	SC5030TK	SPM5020	444744	444699	ESR71036
					ESR80036
					3 Phase - 6 Pole
ESR63016	SC5030TK	SPM5035	444744	444702	ESR63038
ESR71016	SC5050TK	SPM5060	444744	444703	ESR71038
					ESR80038

\*Not suitable for voltage speed control. Inverter speed control with sine filters only.

Model Ref	Roof Cowl Assembly	Drop in Curb Attenuator		
	ONLY (No Fan) Stock Ref	(600mm) Stock Ref	(900mm) Stock Ref	(1200mm) Stock Ref
ESR250	-	RAZ300600	RAZ300900	-
ESR315 & 355	RCZ300	RAZ300600	RAZ300900	RAZ3001200
ESR400 & 450	RCZ400	RAZ400600	RAZ400900	RAZ4001200
ESR500 & 560	RCZ500	RAZ500600	RAZ500900	RAZ5001200
ESR630	RCZ630	RAZ600600	RAZ600900	RAZ6001200
ESR710	RCZ630	RAZ600600	RAZ600900	RAZ6001200
ESR800	RCZ800			
ESR1000	RCZ1000			

Speed Controllers						Adaptor Units (Purlin Box)
Auto Transfor Stock Ref	Starter Stock Ref	Overload Stock Ref	Shutters Stock Ref	Birdguard Stock Ref		
RDTK10	444747	444699	RSZ300	BGZ300	PBZ300	
-	444747	444700	RSZ300	BGZ300	PBZ300	
			RSZ300	BGZ300	PBZ300	
RDTK10	444747	444697	RSZ300	BGZ300	PBZ300	
RDTK10	444747	444698	RSZ300	BGZ300	PBZ300	
RDTK10	444747	444699	RSZ400	BGZ400	PBZ400	
RDTK10	444747	444699	RSZ400	BGZ400	PBZ400	
RDTK20	444747	444700	RSZ500	BGZ500	PBZ500	
RDTK40	444747	444701	RSZ500	BGZ500	PBZ560	
RDTK40	444747	444702	RSZ630	BGZ630	PBZ630	
RDTK70	444747	444703	RSZ630	BGZ630	PBZ710	
RDTK10	444747	444697	RSZ300	BGZ300	PBZ300	
RDTK10	444747	444697	RSZ400	BGZ400	PBZ400	
RDTK10	444747	444699	RSZ500	BGZ500	PBZ500	
RDTK10	444747	444699	RSZ500	BGZ500	PBZ560	
RDTK20	444747	444700	RSZ630	BGZ630	PBZ630	
RDTK40	444747	444702	RSZ630	BGZ630	PBZ710	
RDTK40	444747	444702	-	INCL	PBZ800	
-	444748	444706	-	INCL	PBZ1000	
RDTK10	444747	444699	RSZ630	BGZ630	PBZ630	
RDTK20	444747	444700	RSZ630	BGZ630	PBZ710	
RDTK20	444747	444701	-	INCL	PBZ800	

Note:

- The Standard roof cowl colour is BS 00A 05 (Goose Wing Grey) for all special B.S. or RAL colours contact Vent-Axia.
- When speed control is required a 5 step auto transformer speed controller is recommended, to ensure low noise levels.
- All 3 phase models are suitable for frequency inverter speed control.
- Vent-Axia only recommend using inverters with integral sine filters for reliable operation.