

Sentinel

Kinetic 200Z & 200ZH
300ZH

User Instructions



Model	Stock Ref. N°
200Z	448733A
200ZH	449540A
300ZH	449536A

Vent-Axia[®]

PLEASE RETAIN THESE INSTRUCTIONS WITH THE PRODUCT.

UK
CA
CE

IMPORTANT SAFETY INFORMATION



PLEASE READ THESE INSTRUCTIONS CAREFULLY BEFORE USING THE UNIT.

1. This appliance is not intended for use by persons (including children) with reduced physical, sensory or mental capabilities, or lack of experience and knowledge, unless they have been given supervision or instruction concerning use of the appliance by a person responsible for their safety.

Young children should be supervised to ensure that they do not play with the appliance.

2. Do not attempt to remove the covers of this unit. High Voltage is present in this unit.

NEW PROPERTY FILTER MAINTENANCE

When fitted to a new build property the supply and exhaust filters should be checked at one month intervals for the first six months.



Disposal

This product should not be disposed of with household waste. Please recycle where facilities exist. Check with your local authority for recycling advice.

Contents

Product Description	3
Sentinel Kinetic 200Z, 200ZH & 300ZH	3
Remote Wired Control Display	4
Technical Specification	5
Technical Specification	5
Getting Started	6
Powering Up the Unit	6
Startup Screens	6
Operation and Monitoring	7
Overview	7
User Menu Screens	8
Summer Mode Screens	9
Boost & Purge Screens	10
Status Message Screens	11
Maintenance	13
Caring for the Unit	13
Filter Maintenance	13
12 Monthly Maintenance	13
Troubleshooting	17
Diagnosing a Problem	17

Product Description

Sentinel Kinetic 200Z, 200ZH, 300ZH

The Vent-Axia **Sentinel Kinetic 200Z, 200ZH, 300ZH Mechanical Ventilation / Heat Recovery (MVHR)** is a heat recovery unit designed for the energy efficient ventilation of houses and similar dwellings, conforming to the latest requirements of the Building Regulations document F 2010.

The unit is designed for continuous 24 hour exhaust ventilation of stale moist air from bathrooms, toilets and kitchens. As the stale air is extracted a heat exchanger within the unit transfers the heat into the supply air entering the bedrooms and lounge.

Sentinel Kinetic 200Z, 200ZH, 300ZH Summer By Pass.

The Sentinel Kinetic units are fitted with a Summer By Pass (SBP) and will provide energy-free heating and energy-free cooling when the house temperature and ambient temperature allows.

If the room is warmer than the set (shown as "indoor") temperature (i.e. you need the room to be cooler) and the outdoor air is cooler than the actual room temperature (i.e. the outdoor air could cool your room) then the SBP will open and the unit will supply cooler air to your room.

If the room is cooler than the set ("indoor") temperature (i.e. you need the room heating) and the outdoor air is warmer than the actual room temperature (i.e. the outdoor air could heat your room) then the SBP will open and the unit will supply warmer air to your room.

Note that the above only applies whilst the outdoor air temperature is above 14C (adjustable) in order to prevent cold draughts.

The set ("indoor") temperature should be set 2 or 3 degrees higher than the central heating thermostat and 2 or 3 degrees below any air conditioning thermostat if fitted. This will prevent any clash between the separate systems

Models

- **448733A - Sentinel Kinetic 200Z** with Summer Bypass and Wired Remote Control.
- **449540A - Sentinel Kinetic 200ZH** with Summer Bypass, Integral humidity sensor & Wired Remote Control.
- **449536A - Sentinel Kinetic 300ZH** with Summer Bypass, Integral humidity sensor & Wired Remote Control.

Accessories

- **441838** - Sentinel Kinetic plug-in integral humidity sensor
- **441780** - Vent-Wise accessory pack.

A range of sensors can be used to manage system demand and control the ventilation rate. These include an internal humidity sensor, humidity sensors for independent mounting in rooms, CO₂ sensor, Ventwise sensors, manual switches and pull cords. For these alternative control options, see www.vent-axia.com

Wired remote Control Display

The Wired remote Control provides the user interface for commissioning and monitoring purposes.



Display

The main display is an LCD (see Overview on page 7).

Normal Airflow
30%

Buttons

Four buttons on the Control Unit provide the controls for configuring and monitoring the unit.

Table 1: Control Unit Buttons

Button	Function										
	Press to adjust settings and press to save settings.										
	Press to go to the above screen or to increase a parameter value. Press and hold for more than 2 seconds for fast scrolling.										
	Press to go to the next screen or to decrease a parameter value. Press and hold for more than 2 seconds for fast scrolling.										
	<p>Press to activate Boost mode.</p> <table border="1"> <thead> <tr> <th>No. of presses</th> <th>Boost action</th> </tr> </thead> <tbody> <tr> <td>1</td> <td>Boosts for 30 minutes</td> </tr> <tr> <td>2</td> <td>Boosts for 60 minutes</td> </tr> <tr> <td>3</td> <td>Boosts continuously</td> </tr> <tr> <td>4</td> <td>Back to Normal flow rate</td> </tr> </tbody> </table> <p>Press and hold for 5 seconds to activate Purge mode. (Press and hold for 5 seconds to cancel Purge).</p>	No. of presses	Boost action	1	Boosts for 30 minutes	2	Boosts for 60 minutes	3	Boosts continuously	4	Back to Normal flow rate
No. of presses	Boost action										
1	Boosts for 30 minutes										
2	Boosts for 60 minutes										
3	Boosts continuously										
4	Back to Normal flow rate										

Technical Specification

	Sentinel Kinetic 200Z & 200ZH	Sentinel Kinetic 300ZH
Power		
AC Voltage Input	220-240 V AC (single phase)	
AC Frequency Input	50 Hz nominal	
Supply Fuse	3 A (located in fused spur)	
Product Fuse	2 A (located on main PCB)	
Rated Power	175W (max.)	180W (max.)
Physical		
Height excluding mounting brackets	200mm	300mm
Width	570mm	700mm
Length excluding spigots	800mm	890mm
Weight	26.5Kg	38.5Kg
Spigot diameter	125 mm	150mm
Condensate pipe diameter	22 mm	
Environmental		
IP Rating	IP22	
Operating Temperature	-10°C to +45°C	
Operating Humidity	0% to 95% RH	

For all other technical details, please see the Product Catalogue or our website at www.vent-axia.com.

Powering Up the Unit

Switching On (The unit is designed to run continuously)

To switch the unit on:

1. Switch on the power at the mains supply isolator feeding the unit.
2. Following switch-on, the fan motors will start and the Control Unit will display a series of startup screens, described below.

Switching Off

To switch the unit off: at the unit's local isolator, turn the power off.

Startup Screens

Sentinel Kinetic Version Screen

The Sentinel Kinetic Version screen displays the firmware version number for 3 seconds.

No adjustments are possible on this screen.

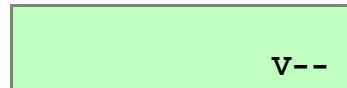

Language Screen

The Language screen displays the language used for the screens. It is typically displayed for 5 seconds, or longer if changing the setting.

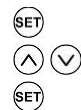
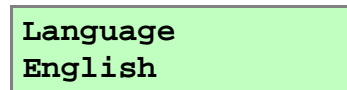

Control Mode Screen

This allows a choice between the control mode described in this document and an alternative control mode.

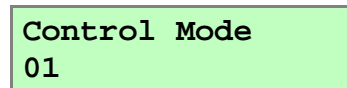

Airflow Units Screen

The Airflow Units is a percentage of the unit's maximum flow.

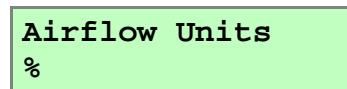

Wireless Control Screen

Not Available.

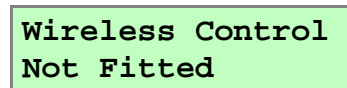

Humidity Sensor Screen

The Humidity Sensor screen displays whether the humidity sensor is fitted. It is typically displayed for 3 seconds.

(200ZH & 300ZH will display **Fitted**)

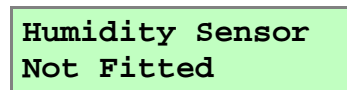

Operation and Monitoring

Overview



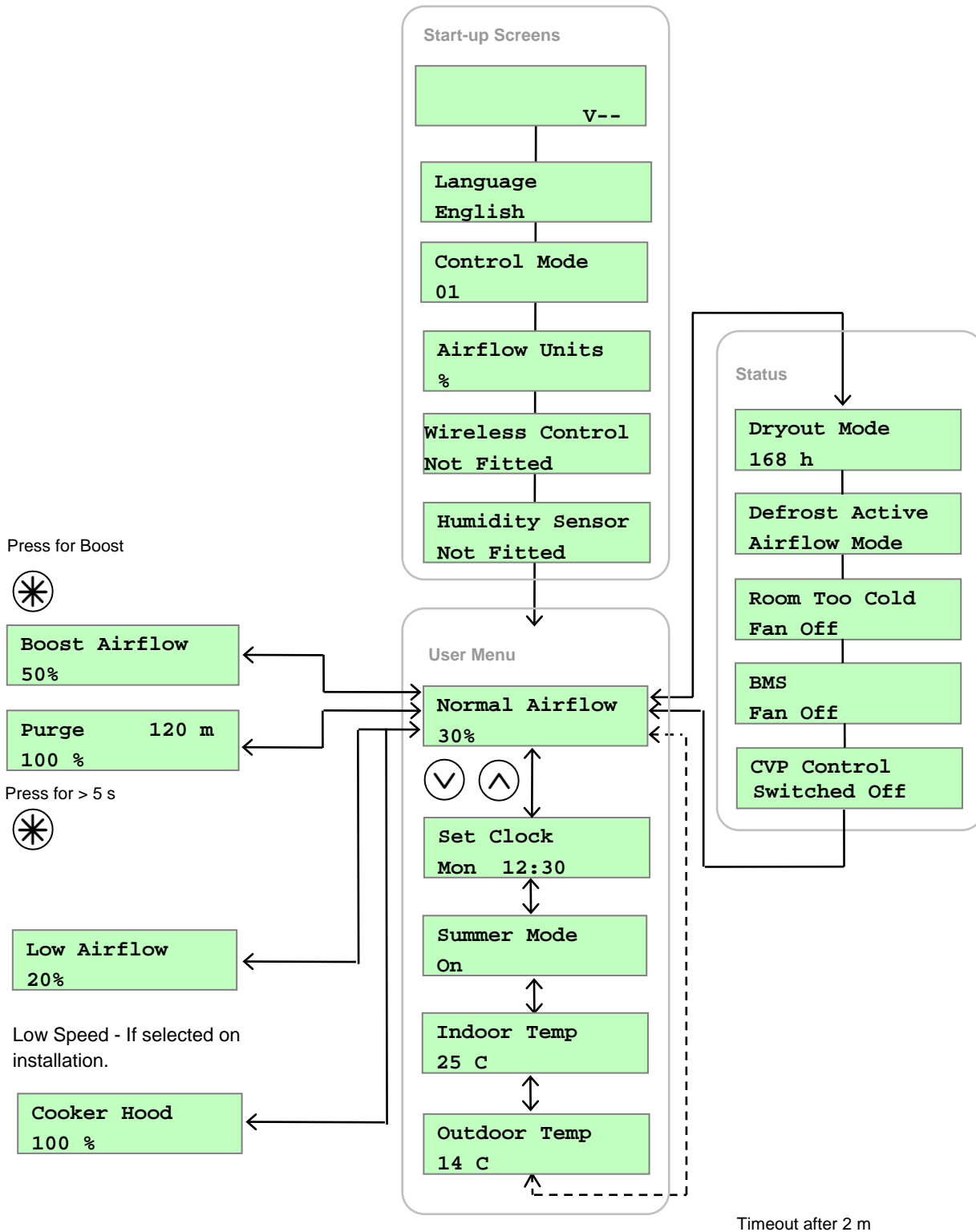



When the Sentinel Kinetic unit has been installed and commissioned it should require no further intervention in order to operate, unless external switches are used to control on/off/boost, etc, or BMS control requires user action.





User Menu Screens

From the Normal Airflow screen, press the  button to access the rest of the User Menu screens.

Changing the value of a setting (if adjustable) is typically a 3-step procedure:

1. Press  to select the setting (the setting will flash).
2. Use the  or  buttons to adjust the value. To scroll quickly, press and hold the  or  buttons for more than 2 seconds.
3. Press  again to enter the new settings and move to the next screen.

To return to the Normal Airflow screen, press the  button repeatedly or press and hold the  button for 5 seconds. Alternatively, the Normal Airflow screen will be restored if no buttons are pressed for two minutes (timeout). Settings are stored in a the memory and will be retained in the event of mains power supply failure.

Low Airflow / Normal Airflow / Boost Airflow Screen

When the start-up screens are finished, the Low or Normal screen is displayed showing operating status (Low Airflow X % or Normal Airflow X % or Boost Airflow X %).

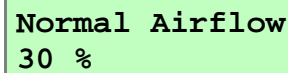

Normal Airflow
30 %

The Normal screen displays the rate of normal airflow (supply air) through the unit.

If the installation has proportional sensors or an internal humidity sensor fitted, an α symbol will be displayed when they are boosting the airflow.

When the summer bypass is active, the normal screen top line will alternate (for 3 seconds) with Summer Bypass.

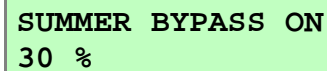

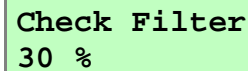

SUMMER BYPASS ON
30 %

An interval can be set, see the Installation and Commissioning manual, at which the unit reminds the user to check the filters. This will be 6, 12 or 18 months. The normal screen top line will include Check Filter as a reminder to check and, if necessary, clean or replace the filters.



Check Filter
30 %

When this has been done, press and hold the  and  buttons for 5 seconds to reset the automatic message.

Set Clock Screen

From the Normal Airflow screen, simply press the  button once to access the Set Clock screen.

The Set Clock Control screen enables you to change the clock settings. The clock retains its settings for approximately two weeks without mains power, after which it will need resetting when power is reconnected

Values are **DDD HH:MM**.

Return to the normal display by pressing the  button or leave to timeout and return automatically after 2 minutes.

The unit will not automatically switch for Daylight saving time.

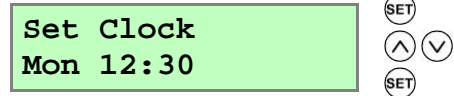

Summer Mode Screen

From the Set Clock screen, simply press the  button twice to access the Summer Mode screen.

If the unit is a summer bypass model, the Summer Mode screen enables you to switch the summer bypass control on or off. This screen is only displayed when the bypass is fitted.

Options available are **On** (default) and **Off**.

Return to the normal display by pressing the  button or leave to timeout and return automatically after 2 minutes.

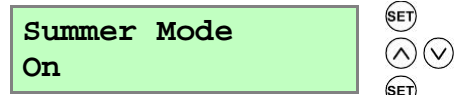

Indoor Temp Screen

From the Summer Mode screen, simply press the  button 3 times to access the Indoor Temp screen.

The Indoor Temp screen enables you to choose the target room temperature in degrees Centigrade – only displayed when the bypass is fitted.

Selectable range is **16-40** (**25** default).

Return to the normal display by pressing the  button or leave to timeout and return automatically after 2 minutes.

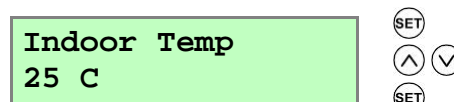

Boost & Purge Screens

Boost Screen

Pressing the  button activates boost airflow mode when extra ventilation is required.

No. of presses	Boost action
1	Boosts for 30 minutes
2	Boosts for 60 minutes
3	Boosts continuously
4	Back to Normal flow rate

Boost Airflow
50 %

If the installation has switch sensors, is wired to the lighting, has Vent-Wise sensors or if the internal time switch is set for periodic operation, operation will change from normal to boost automatically. Pressing the  button will reveal a code to show which device has activated boost.

s1 = Switch S/W1

s2 = Switch S/W2

s3 = Switch S/W3

s4 = Switch SW4

s5 = Switch SW5

v1 = Vent-Wise Input S/W1

v2 = Vent-Wise Input S/W2



v3 = Vent-Wise Input S/W3

ls = Switched live (LS)

c1-3 = Internal Time switch

If running on boost due to pressing the  button, a device will 'take over' the boost. Flow will return to low / normal when that device switches off. If a number of different devices are calling for boost flow, the unit will run at boost until the last one has reverted to normal.

Purge Screen

Pressing and holding the  button for 5 seconds activates purge mode when you want to purge air from the building. The unit will revert to normal flow by pressing and holding the  button again for 5 seconds. If the wireless boost option is fitted, this can be triggered from the wireless transmitter/boost switch.

Purge mode runs the fans at full speed for 2 hours (120 minutes). The Purge screen displays a countdown of the time remaining.

Purge **120m**
100 %

Low Airflow Screen

Low Airflow mode is activated when the Normal Airflow is set to **Off**.

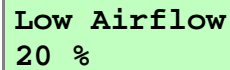

The Normal Airflow mode can be set to run during the daytime i.e. from 6am to 11pm, the Low Airflow mode will then run during the night from 11pm to 6pm.



Low Airflow
20 %

Status Message Screens

The status message screens override the Normal Airflow and other user screens, and display status and key operational conditions (temperatures or pressures, etc.) according to how the unit has been configured. If there is more than one status item to be displayed, the highest priority message is shown.

These screens are displayed in a loop during normal operation of the unit, either after displaying the start-up screens, or when commissioning has been completed. After a few seconds the display backlight is turned off in order to minimise power consumption. The  and  buttons can be used to stop the loop sequence in order to display individual screens for a longer period with the backlight turned on, if required.

Dryout Mode Screen

The Dryout Mode screen displays the time remaining for the building to dry out. The unit runs at maximum flow for 1 week.

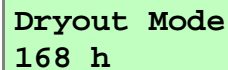

Dryout Mode
168 h

Defrost Active Screen

The Defrost Active screen displays the status of the defrost (antifrost) mode. If the external air drops below 0°C, to reduce the risk of frost forming in the heat exchanger the defrost mode is activated. Defrost mode can either alter the airflows or open the bypass and will be pre-set by the commissioning engineer.

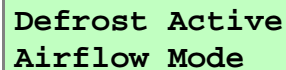

Defrost Active
Airflow Mode

Bottom line of display may be (**Airflow Mode, Bypass Mode**).

Airflow Mode - When the supply air temperature is between 0° and -20°C, antifrost will automatically activate. This will reduce the supply airflow rate and increase the extract airflow rate to prevent frost forming on the heat exchanger. During antifrost operation the supply motor can stop for 15 minutes and run for 45, depending on the temperature below 0°C. If the supply air temperature is -20°C or below the supply fan switches off and the extract fan continues to run at reduced rate to prevent frost forming on the heat exchanger.

Bypass Mode - While the supply air temperature is below 0°C, the defrost mode will automatically activate. This mode will open the bypass to prevent frost forming on the heat exchanger.

Heating Failure Screen

The Room Too Cold screen displays the status of the fan. If the heating system in the building fails or is switched off and the internal temperature drops below 5°C, the unit will stop running so as to not bring cold air into an already cold house. The unit will start up every hour and will run for a short time to measure the temperature of the property. When the temperature rises, e.g. the heating system is switched back on, the unit will restart and continue normal operation.

Bottom line of display may be (**Fan Off, Fan Restarting**).

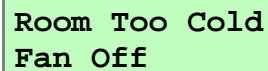

Room Too Cold
Fan Off

BMS Screen

The BMS screen shows if a Fan Off command has been received from a Building Management System (BMS), if used.

A **Fan Off** command could be received from the BMS in the event of a fire alarm.

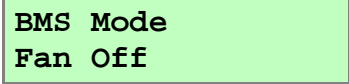



BMS Mode
Fan Off

Maintenance



Caring for the Unit

Heat recovery units, by their very nature, require regular maintenance. The Sentinel Kinetic unit has been designed to facilitate access to enable maintenance to be carried out easily.

Filter Maintenance

Item	Action
Fan Filters	<p>When the unit displays "Check filters". This is a reminder to ensure that the filters are not so dirty that they are blocking the airflow or allowing dirt to pass through. The rate at which the filters become dirty will vary hugely depending on the environment and the activity within the property.</p> <ol style="list-style-type: none"> 1. Remove 2 filter cover plates and filters. 2. Clean gently by tapping or carefully using a vacuum cleaner if necessary. 3. Replace the filters and cover plates 4. Reset the automatic message, press and hold the  and  buttons for 5 seconds.

12 Monthly Maintenance

Item	Action
Fan Filters (Interval to suit environment)	<p>Change the Fan Filters depending on which environment the unit has been installed; urban, suburban or rural.</p> <ol style="list-style-type: none"> 1. Remove 2 filter cover plates and filters. 2. Insert the replacement filters. 3. Replace the filters and cover plates. 4. Reset the automatic message, press and hold the  and  buttons for 5 seconds.
Unit & Heat Exchanger Cell	Inspect and clean the unit: See the following pages
Motors	Inspect the motors for build-up of dust and dirt on the impeller blades, which could cause imbalance and increased noise levels. Vacuum or clean if necessary.
Condensate Drain	Check the condensate drain tube is secure and clear of debris. Clean if necessary.
Fastenings	Check that all unit and wall-mount fastenings are sufficiently tight and have not become loose. Re-tighten if necessary.

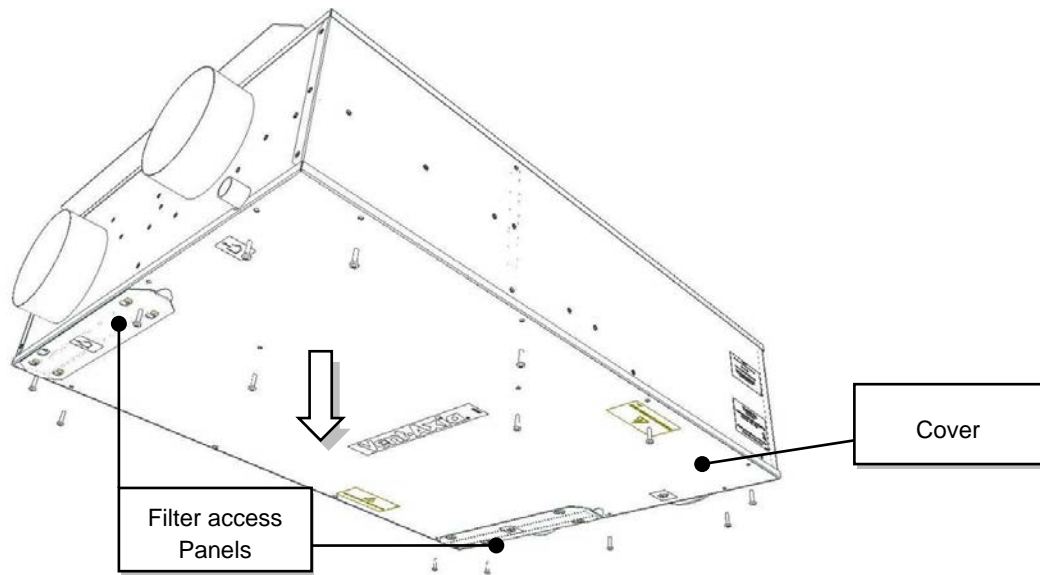

Stage 1: Isolate the mains power supply and remove the Filter access Panels and Filters.
Undo the securing screws and remove the Cover .

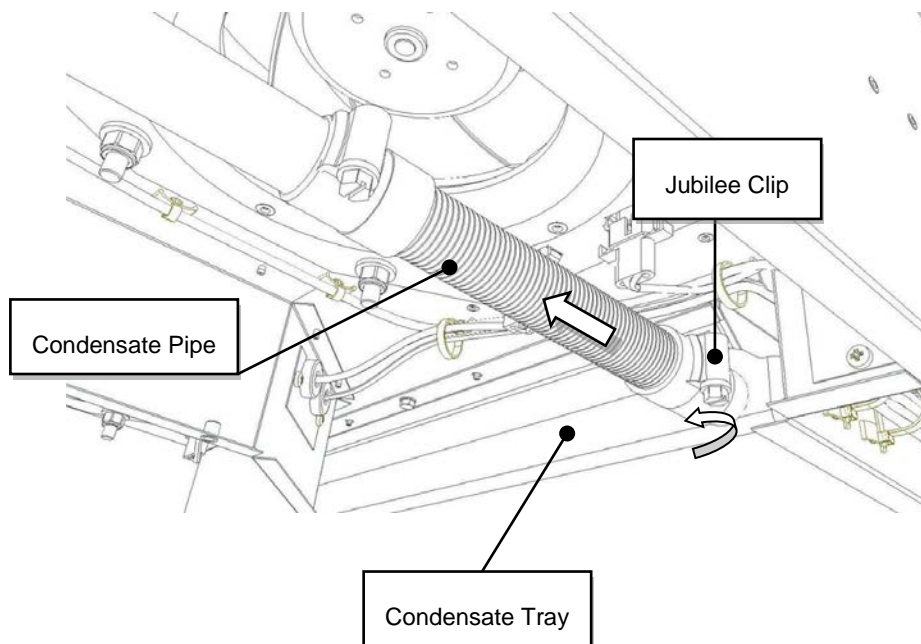

Stage 2: Loosen the Condensate Pipe Jubilee Clip and remove Pipe from Condensate Tray.

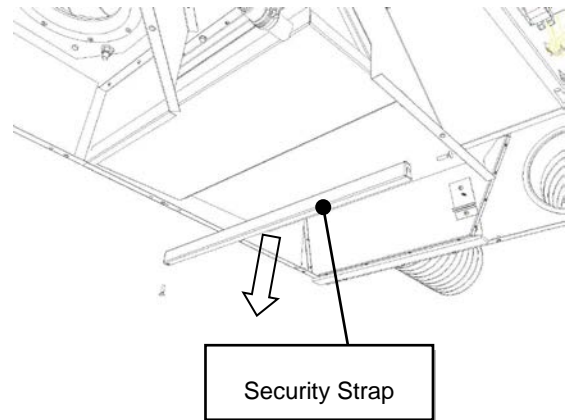
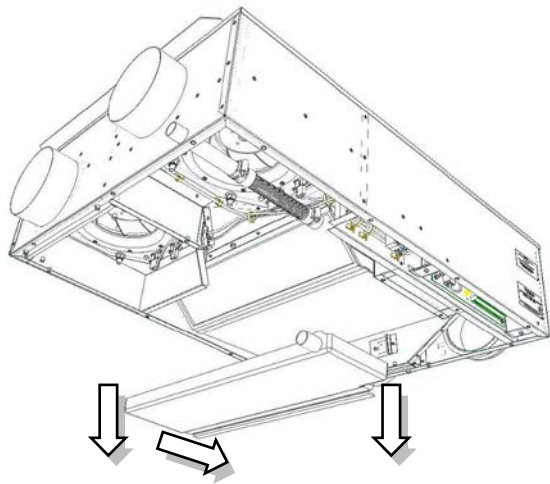

Stage 3: Remove the Condensate Tray.

Note: Remove the additional Security Strap on the 300ZH before removing the Condensate Tray

Caution: Keep the Tray as horizontal as possible as this may contain condensate.

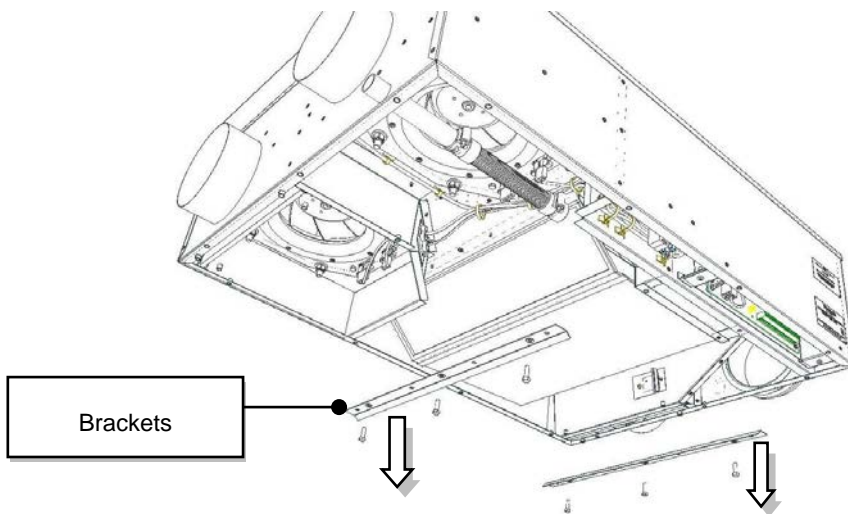

Stage 5: Remove the two Heat Exchanger fixing Brackets and Heat Recovery Cell.

Note : Take care when removing the Heat Recovery Cell.

Cleaning the Heat Exchanger Cell:

Wash the outer cover and heat exchanger in warm water using a mild detergent (such as Milton Fluid) and dry thoroughly.

Reassembly after maintenance:

For re assembly, please reverse this process ensuring the **Heat Exchanger Cell** is re positioned with the "TOP" label visible and that the same level of care and attention is retained in re-applying all fixings to their previous locations.

Spares

The following spares may be ordered from Vent-Axia

Description	Part No 200Z & 200ZH	Part No 300ZH
Filters, 2 per pack	449524	449575
Heat Recovery Cell	449525	449576
Motor assembly	449526	449526
Control PCB	449527	449527
Temperature sensor kit (consists of a T1 & T2 sensor)	449528	449577
Wired remote controller (complete with 15 metre control cable)	443283	443283

Troubleshooting

Diagnosing a Problem

In the event of a problem, always troubleshoot the unit according to:

- **Fault code** displayed on the Remote Wired Control.
- **Fault LED** if connected.

If no indications are displayed, then troubleshoot problem according to the fault symptom as described in the following table.

Service/Fault Code Screens

The Service screen is displayed, alternating with the Fault Code screen, when a fault has caused the unit to switch off and you must phone the telephone number displayed on the screen for assistance.

Service Phone
01293nnnnnn

The Fault Code screen is displayed, alternating with the Service screen, when a fault has occurred. Take note of the fault code when reporting a fault.

Fault Code
01

For assistance contact the service provider and quote the fault code number. The following fault codes numbers may be displayed. Code numbers are added together if more than one is detected.

Table 2: Fault Codes

Code	Problem
01	Supply Fan not running
02	Extract Fan not running
04	PCB 24 V fuse (FS1) failure
08	Temperature sensor T1 (supply) faulty
16	Temperature sensor T2 (extract) faulty
32	Wired Remote Control failure

PRODUCT FICHE

For Residential Ventilation Units (Complying Commission Delegated Regulation (EU)

No 1254/2014)

Name:	Vent-Axia	Vent-Axia	Vent-Axia
Model ID (Stock Ref.) :	Kinetic 200 Z - 448733	Kinetic 200 ZH - 449540	Kinetic 300 ZH - 449536
SEC Class	A	A	A
SEC Value ('Average')	-39.08	-39.08	-37.20
SEC Value ('Warm')	-15.06	-15.06	-13.42
SEC Value ('Cold')	-81.78	-81.78	-79.51
Label Required? (Yes/No=Out of scope)	Yes	Yes	Yes
Declared as: RVU or NRUVU/UVU or BVU	RVU/BVU	RVU/BVU	RVU/BVU
Speed Drive	Variable Speed	Variable Speed	Variable Speed
Type HRS (Recuperative, Regenerative, None)	Recuperative	Recuperative	Recuperative
Thermal Eff: [(%), NA(if none)]	79.00	79.00	77.00
Max. Flow Rate (m3/h)	252.00	252.00	295.20
Max. Power Input (W): (@Max.Flow Rate)	150	150	150
LWA: Sound Power Level (dB)	57.43	57.43	58.23
Ref. Flow Rate (m3/s)	0.05	0.05	0.06
Ref. Pressure Diff. (Pa)	50	50	50
SPI [W/(m3/h)]	0.39	0.39	0.50
Control Factor & Control Typology: (CTRL/ Typology)			
Control Factor; CTRL	0.65	0.65	0.65
Control Typology	Local Demand Control	Local Demand Control	Local Demand Control
Declared: -Max Internal & External Leakage Rates(%) for BVUs or carry over (for regenerative heat exchangers only), -&Ext. Leakage Rates (%) for Ducted UVUs;	<5% Internal, <5% External	<5% Internal, <5% External	<5% Internal, <5% External
Mixing Rate of Non-Ducted BVUs not intended to be equipped with one duct connection on either supply or extract air side;	N/A	N/A	N/A
Position and description of visual filter warning for RVUs intended for use with filters, including text pointing out the importance of regular filter changes for performance and energy efficiency of the unit	Refer to User Instructions	Refer to User Instructions	Refer to User Instructions
For UVUs (Instructions Install Regulated Supply/Extract Grilles Façade)	N/A	N/A	N/A
Internet Address (for Disassembly Instructions)	www.vent- axia.com	www.vent- axia.com	www.vent- axia.com
Sensitivity p. Variation@+20/-20 Pa: (for Non-Ducted VUs)	N./A	N./A	N./A
Air Tightness-ID/OD-(m3/h) (for Non-Ducted VUs)	N./A	N./A	N./A
Annual Electricity Consumption: AEC (kWh/a)	2.50	2.50	3.09
Annual Heating Saved: AHS (kWh/a)			
AHS: Average	44.66	44.66	44.24
AHS: Warm	20.19	20.19	20.01
AHS: Cold	87.36	87.36	86.55

The **Vent-Axia** Guarantee

Applicable only to products installed and used in the United Kingdom. For details of guarantee outside the United Kingdom contact your local supplier.

Vent-Axia guarantees its products for two years from date of purchase against faulty material or workmanship. In the event of any part being found to be defective, the product will be repaired, or at the Company's option replaced, without charge, provided that the product:-

- Has been installed and used in accordance with the instructions given with each unit.
- Has not been connected to an unsuitable electricity supply. (The correct electricity supply voltage is shown on the product rating label attached to the unit).
- Has not been subjected to misuse, neglect or damage.
- Has not been modified or repaired by any person not authorised by the company.

IF CLAIMING UNDER TERMS OF GUARANTEE

Please return the complete product, carriage paid to your original supplier or nearest Vent-Axia Centre, by post or personal visit. Please ensure that it is adequately packed and accompanied by a letter clearly marked "Guarantee Claim" stating the nature of the fault and providing evidence of date and source of purchase.

Vent-Axia

Head Office: Fleming Way, Crawley, West Sussex, RH10 9YX.

EU Authorised Representative: Vent-Axia Bedrijvenweg 17 7442 CX Nijverdal Nederland
authorisedrep@vent-axia.nl

UK NATIONAL CALL CENTRE, Newton Road, Crawley, West Sussex, RH10 9JA

SALES ENQUIRIES: Tel: 0844 8560590 Fax: 01293 565169

TECHNICAL SUPPORT Tel: 0844 8560594 Fax: 01293 532814

For details of the warranty and returns procedure please refer to www.vent-axia or write to Vent-Axia Ltd, Fleming Way, Crawley, RH10 9YX