

Warmair3 & Warmair4.5 Warm Air Curtains

Installation & Wiring Instructions

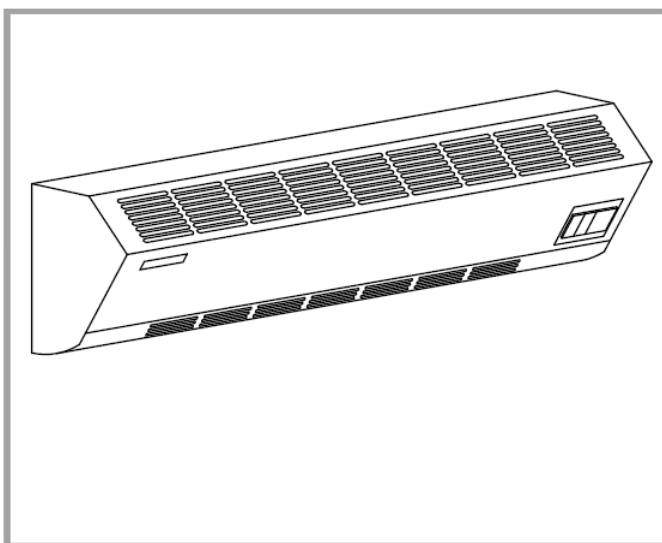

Stock Ref No.

456343A Warmair3

456344A Warmair4.5

230-240V 50Hz

Vent-Axia[®]

PLEASE READ INSTRUCTIONS IN CONJUNCTION WITH THE ILLUSTRATIONS.
PLEASE SAVE THESE INSTRUCTIONS



These instructions describe the various technical details of your “Warmair” 635mm 3kW or 4.5kW air –curtains and there use. The air-curtains have a fan and heater designed to mount above a doorway, or similar, in industrial or commercial situations.

Safety & Guidance Notes

All wiring to be in accordance with the current I.E.E Regulations, or the appropriate standards of your country and **MUST** be installed by a suitably qualified person.

Ensure that the mains supply (Voltage, Frequency, and phase) complies with the rating label.

DO NOT use this appliance where the following are general or present:-

Excessive moisture, excessive dust or fibres, grease or oil laden air, corrosive or flammable atmospheres.

DO NOT use this appliance in bathrooms

DO NOT handle the appliance with wet hands

DO NOT cover or partially cover the appliance. The tangential fan **MUST** have free air flow at all times, i.e. do not mount close to cupboards, etc.

Children, the elderly and the infirm may not always be aware of the danger involved in using electrical appliances. Never allow this appliance to be used without supervision.

Mounting

When mounted over a standard shop doorway the unit should be fitted as low as possible and not more than 2.3 meters from ground level. A single unit will provide reasonable coverage for a one metre doorway, and for wider doorways units can be mounted end to end.

The unit should be positioned so that the airflow is not obstructed by any part of the doorframe.

When “ceiling” mounted, the discharge grille must protrude through the false ceiling as shown. All the slots must be below the ceiling line. Provision must be made, in the void above the false ceiling, for an adequate supply of air to the inlet side of the unit (see diagram below and right).

Installation

Carefully unpack the unit and remove the top cover fixing screws. The heater may be mounted using the mounting bracket provided.

Loosen mounting screws, allowing the mounting bracket to be removed from the unit. Making sure that the mounting is horizontal, fix the bracket to the wall using 4 x No8 wood screws. Place the unit on the mounting bracket ensuring the washers are spaced as on diagram (a plain washer either side of the mounting bracket).

Tighten screws to hold the unit at the required angle.

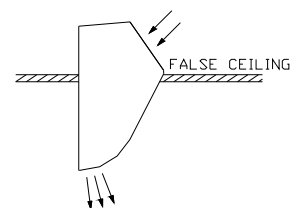
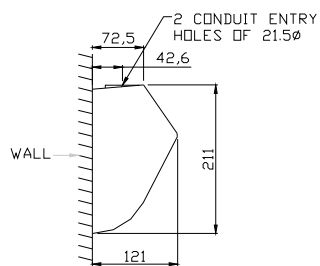
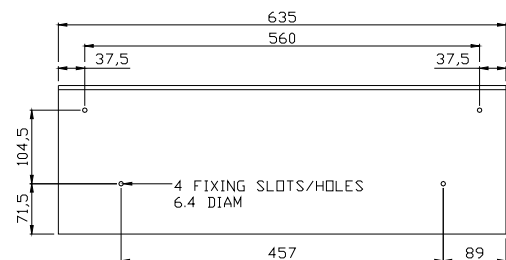
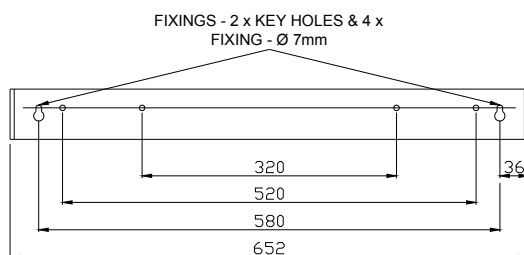

The heater may also be mounted in one of the following ways:-

1. Direct to a suitable wall or bearer by four No.8 wood screws through the holes provided in the back of the unit casing. Keyhole slots are provided for the top two fixings.

2. Suspended by 20mm conduit through the holes provided in the top of the unit.

3. Suspended by chains through the holes provided in the top of the unit.

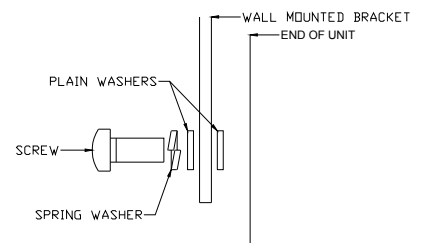
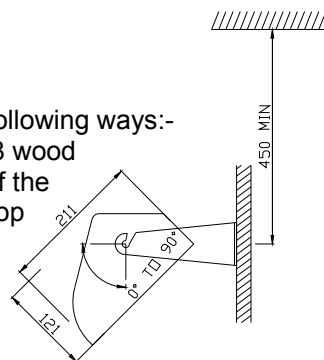

Electrical Connections

WARNING: ALWAYS ISOLATE THE MAINS SUPPLY BEFORE INSTALLATION, SERVICING OR MAINTENANCE.

All Regulations and requirements **MUST** be strictly followed to prevent hazards to life and property both during and after installation and during any subsequent servicing and maintenance.

This Appliance MUST be Earthed

These units are suitable for connection to a 230/240 volt 50Hz single phase ac supply. The heaters consume 3kW & 4kW respectively at 240 volts when switched to the full heat position. (See below for wiring diagrams)

The appliance should be connected to the supply via a circuit in which there is an all-pole switch. Test for correct operation and refit the cover.

Operation

The right hand switch connects the mains supply To the fan motor (giving a cool airflow) and Energises the heat control switches.

Heat control (3kW Warmair)

When the centre switch (marked with a single bar) is depressed the heat output is 1kW. When the left-hand switch (marked with a single bar) is depressed the heat output is 2kW. When both switches are depressed the heat output is 3kW.

Heat control (4.5kW Warmair)

When the centre switch (marked with a single bar) is depressed the heat output is 1.5kW. When the left-hand switch (marked with a single bar) is depressed the heat output is 3kW. When both switches are depressed the heat output is 4.5kW.

Maintenance

WARNING: ALWAYS ISOLATE THE MAINS SUPPLY BEFORE INSTALLATION, SERVICING OR MAINTENANCE.

To obtain the best results from your heater it is necessary to avoid the build up of dust and dirt within the unit and on the air inlet and discharge grilles. For this reason regular cleaning is necessary, paying particular attention to the removal of dirt build up on the rotor blades. A single drop of light oil should be applied to the motor bearing from time to time.

Protection (Thermal cut-out)

The units are protected in the event of fan failure, or an obstruction of the free airflow, by thermal PTC self hold cut-outs. Having tripped, the PTC cut-out remains open, effectively switching off the heating elements, as long as mains power is available inside the appliance.

To reset the PTC self-hold cut-out proceed as follows:-

DO NOT ADJUST BY HAND ANY COMPONENTS

1. The cut-out is reset by switching OFF the mains power to the heater.
2. Allow the heater to cool for 20 minutes.
3. Restart, Switch ON the heater. If the cut-out trips again consult a qualified electrician.

3kW Warmair

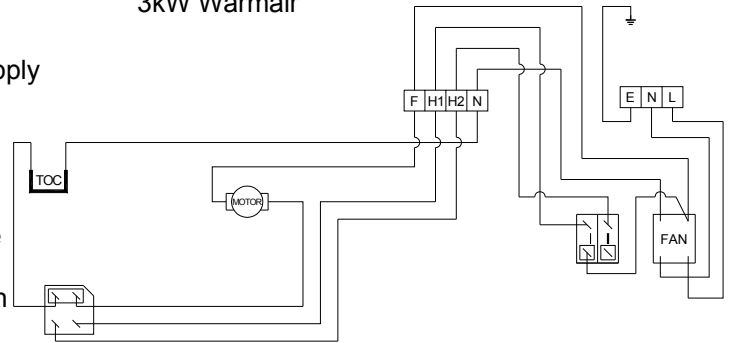

4.5kW Warmair

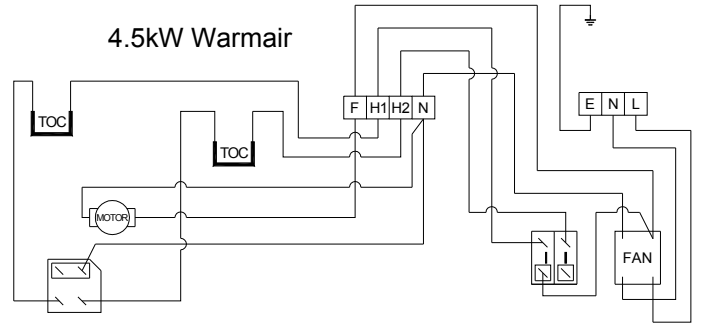

The **Vent-Axia**® Guarantee

Applicable only to products installed and used in the United Kingdom. For details of guarantee outside the United Kingdom contact your local supplier.

Vent-Axia guarantees its products for two years from date of purchase against faulty material or workmanship. In the event of any part being found to be defective, the product will be repaired, or at the Company's option replaced, without charge, provided that the product:-

- Has been installed and used in accordance with the instructions given with each unit.
- Has not been connected to an unsuitable electricity supply. (The correct electricity supply voltage is shown on the product rating label attached to the unit).
- Has not been subjected to misuse, neglect or damage.
- Has not been modified or repaired by any person not authorised by the company.

IF CLAIMING UNDER TERMS OF GUARANTEE

Please return the complete product, carriage paid to your original supplier or nearest Vent-Axia Centre, by post or personal visit.

Please ensure that it is adequately packed and accompanied by a letter clearly marked "Guarantee Claim" stating the nature of the fault and providing evidence of date and source of purchase.

The guarantee is offered to you as an extra benefit, and does not effect your legal rights

Vent-Axia®

Head Office: Fleming Way, Crawley, West Sussex, RH10 9YX.

UK NATIONAL CALL CENTRE, Newton Road, Crawley, West Sussex, RH10 9JA

SALES ENQUIRIES: Tel: 0844 8560590 Fax: 01293 565169

TECHNICAL SUPPORT: Tel: 0844 8560594 Fax: 01293 539209

For details of the warranty and returns procedure please refer to www.vent-axia.com or write to Vent-Axia Ltd, Fleming Way, Crawley, RH10 9YX