



Vent-Axia[®]

The UK's Leading Ventilation Company

Vent-Axia Pure Air

1st Edition

www.vent-axia.com/pureair





A filter to take care of health and home

The focus on Indoor Air Quality has never been as strong as it is today. Pressure on local councils require air quality reports to be completed in most habitable areas whilst changes to local construction legislation puts responsibility on developers to ensure air to dwellings is filtered to increasingly higher standards.

Whilst the Vent-Axia Mechanical Ventilation with Heat Recovery (MVHR) range offers high levels of particle filtration, up to and including F7, the New Vent-Axia Pure Air now sets the benchmark for high level filtration. The Vent-Axia Pure Air targets pollutants generated outside of the home, by traffic and industrial processes, and reduces these before supplying the air into the dwelling.

MVHR is the most energy efficient and effective method of ventilation in new homes. Air is extracted from 'wet' rooms (bathrooms, kitchen) and exhausted to outside. At the same time fresh, filtered, pre-warmed air is supplied into

'habitable' rooms (lounge and bedrooms). Clean filtered air is circulated throughout the home every two hours.

MVHR not only extracts harmful pollutants but also allows the air coming into the home to be filtered, taking out harmful airborne bacteria and dangerous contaminants. The Vent-Axia Pure Air filter is fitted to the intake airflow and incorporates two types of filtration:

- Enhanced activated Carbon which removes unpleasant odours and harmful gasses such as Nitrous Oxide (NO₂).
- G4 or F7 particulate filters which can remove tiny airborne contaminants such as pollen, bacteria and even PM2.5 diesel particulates.

The combination of MVHR and Vent-Axia Pure Air filtration offers the ideal indoor environment.

Vent-Axia[®]



Vent-Axia Pure Air

The Indoor Air Quality Filtration System



Particle Filtration

Vent-Axia Pure Air is available with G4 or F7 particle filters. G4 filters can remove up to 90% of the PM10 particles in the air, this includes some bacteria, most pollens and many types of industrial dust. The finer F7 filters remove up to 80% of the tiny PM2.5 particles, this includes fine diesel particulates.



Nitrogen Dioxide Filter

In urban areas vehicles are responsible for about 99% of Nitrogen Dioxide pollution. Respiratory problems and increased incidences of asthma result from high levels of NO₂. The Vent-Axia Pure Air filters incoming air, helping to meet World Health Organisation guidelines for NO₂ levels in homes.

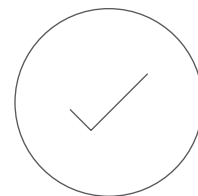

Meeting IAQ levels

Particle filters conform to EN 779 and combined with specially formulated gas filters, help meet indoor air quality levels conforming to EU Directive 2008/50/EC.

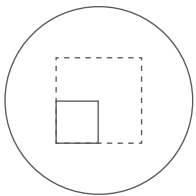

Extensive Model Range

From small apartments to large offices, Vent-Axia Pure Air has a range of sizes to suit. The size and specification of each unit will be determined by the required airflow of each application.

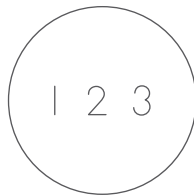

Spigot Options

A range of rectangular and round spigot sizes, including combinations of both offer unique versatility at the point of installation. The filter unit can be installed vertically or horizontally allowing optimum use of space.

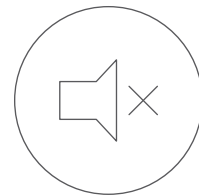

Noise Attenuation

In addition to improving air quality, external noise is attenuated as it passes through the unit thus reducing induct noise and helping to achieve specified sound levels in dwellings.

Consultant's Specification

Product Specifications

The unit shall comprise of a galvanised steel outer casing. Physical media panel filters contained in a cardboard housing shall be located at both spigot ends of the unit. Panel filters of Grade G4 to EN779 having an arrestance above 90% making it suitable for the removal of PM10 particulates. An additional particulate filter of grade F7 to EN779 can be included to further reduce smaller particles (PM2.5) to an efficiency between 80 and 80% at 0.4µm.

Example Stock Ref:

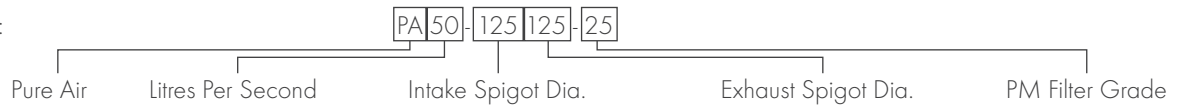

Stock Ref	Airflow l/s	Intake Spigot (mm)*	Exhaust Spigot (mm)*	Filter Types	Clean Filter Pressure Drop (Pa)	Approximate Unit Weight (kg)	Curve Ref
PA50-125125-25	50	125Ø	125Ø	PM2.5	100	25	1
PA50-125204-25	50	125Ø	204 x 60	PM2.5	100	25	1
PA50-204204-25	50	204x60	204x60	PM2.5	100	25	1
PA50-125125-10	50	125Ø	125Ø	PM10	45	25	2
PA50-125204-10	50	125Ø	204x60	PM10	45	25	2
PA50-204204-10	50	204x60	204x60	PM10	45	25	2
PA100-150150-25	100	150Ø	150Ø	PM2.5	100	49	3
PA100-150220-25	100	150Ø	220x90	PM2.5	100	49	3
PA100-220220-25	100	220x90	220x90	PM2.5	100	49	3
PA100-150150-10	100	150Ø	150Ø	PM10	45	49	1
PA100-150220-10	100	150Ø	220x90	PM10	45	49	1
PA100-220220-10	100	220x90	220x90	PM10	45	49	1
PA200-200200-10	200	200Ø	200Ø	PM10	45	96	4
PA200-250250-10	200	250Ø	250Ø	PM10	45	96	4
PA300-315315-10	300	315Ø	315Ø	PM10	45	144	5

*Airflow may be reversed through the unit to offer alternative spigot options.

Accessories

Model	Stock Ref.
50 l/s insulating jacket	PAJAC-50
100 l/s insulating jacket	PAJAC-100
Spare PM2.5 filter	PAFIL-25
Spare PM10 filter	PAFIL-10
Spare Gas filter	PAFIL-NO2

Installation

The Vent-Axia Pure Air may be installed in a vertical or horizontal orientation. When installing on the 'atmosphere' side of the MVHR unit, insulated jackets are available. Access to filters is available on both sides via bolted lift off panels. Various spigots including rectangle and round are available to suit ductwork systems for both domestic and commercial duct work.

Pollutant Gases, NO₂, SO₂, O₃, VOC

A specially formulated activated carbon and chemical mix acts upon pollutant concentrations common in dirty city air, reducing them to below guidelines set by current legislation. Gas and particulate filters are removable from either side of the unit.

Unit Configuration

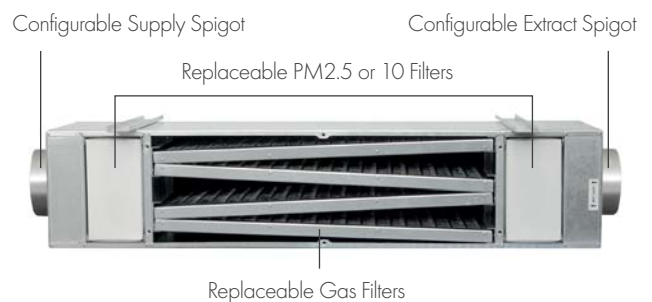

Technical Specification

Dimensions (mm)

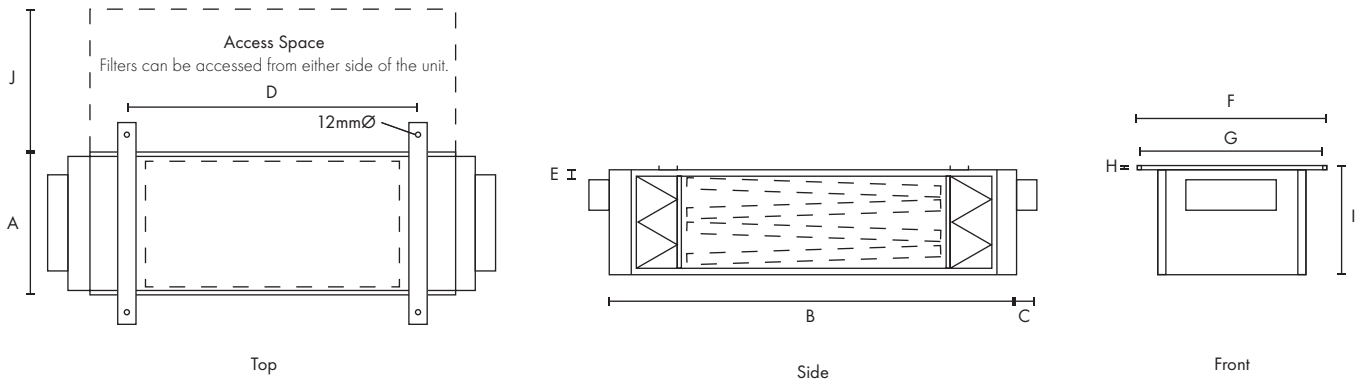

Airflow l/s	A	B	C	D	E	F	G	H	I	J
50	310	980	50	700	25	435	405	10	220	340
100	620	980	50	700	25	730	700	10	220	650
200	620	980	50	700	110/85	730	700	10	420	650
300	620	980	50	700	160	730	700	10	630	960

Spigot Configuration

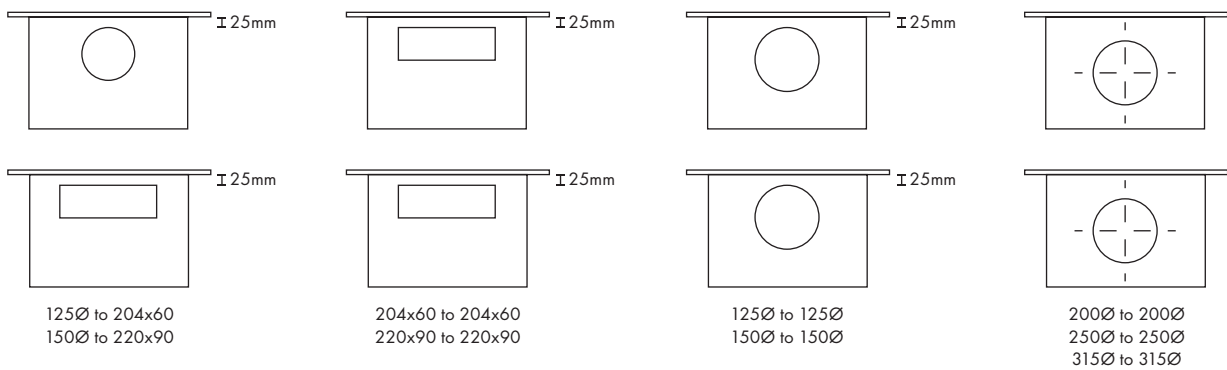

Pressure Drop

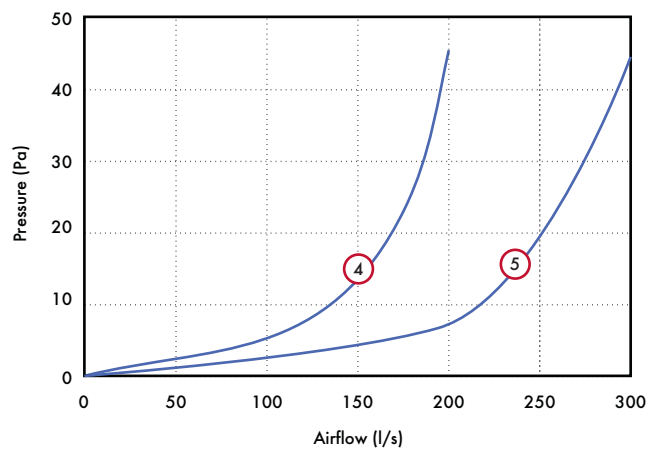
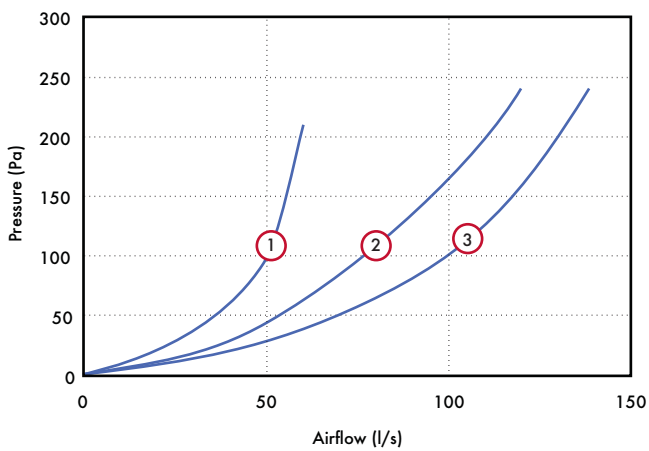

Vent-Axia®

VENT-AXIA CONTACT NUMBERS

Free technical, installation and sales advice is available

Sales Centre:

Domestic & Commercial

Sales Tel: 0844 856 0590
Sales Fax: 01293 565169
Tech Support Tel: 0344 856 0594
Tech Support Fax: 01293 532814

Heating Support

Sales Tel: 0844 856 0590
Tech Support Tel: 0344 856 0594

Industrial

Sales Tel: 0844 856 0591
Sales Fax: 01293 534898
Tech Support Tel: 0344 856 0595
Tech Support Fax: 01293 532814

Web: www.vent-axia.com

Email: sales@vent-axia.com

Supply & Service

All sales made by Vent-Axia Limited are made only upon the terms of the Company's Conditions of Sale, a copy of which may be obtained on request. As part of the policy of continuous product improvement Vent-Axia reserves the right to alter specifications without notice.



A British company supporting British manufacturing
Vent-Axia Group Ltd Products you can trust